

# A2001 PH CONNECTOR

2.00mm Pitch/Disconnectable Crimp style connectors

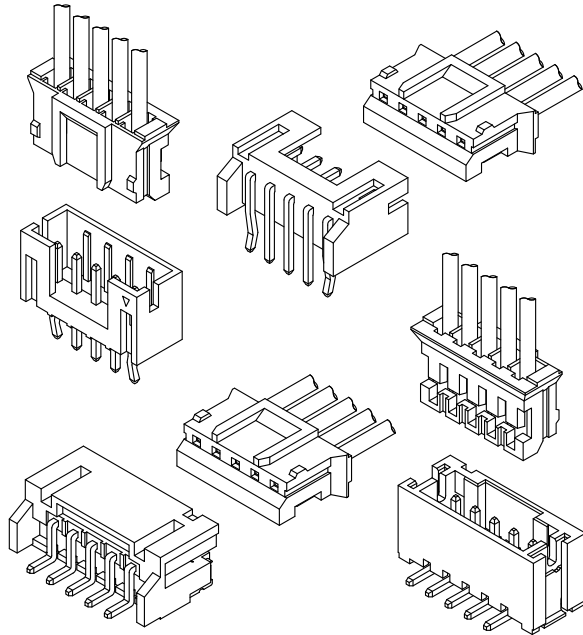

- Secure locking structure
- Low insertion force
- Suction area for picking up
- Improvement of engagement with prying

## Specifications:

- Current rating: 2.0 A / AC,DC
- Voltage rating: 100 V AC/DC (AWG #22)
- Temperature range: -40°C ~ +105°C  
(including temperature rise in applying electrical current)
- Contact resistance: Initial value/ 20m Ω max  
Insulation resistance: 1000 M Ω min  
Withstanding voltage: 800 VAC/minute  
Applicable wire: Conductor size/ AWG#30~#22  
Insulation O.D./ 0.70 to 1.50 mm
- \* Compliant with RoHS2/ REACH/ HF
- \* Refer to "General Instruction and Notice when using Terminals and Connectors"
- \* Contact CSG for details

## Material:

Housing: PA66/UL94-V0;Color:White/ Black  
Terminal: Phosphor/ Tin-plated  
DIP Wafer Housing: PA66,UL94-V0;Color:White  
DIP Wafer Pin: Brass/ Tin-plated  
SMT Wafer Housing: LCP,UL94-V0;Color:Natural  
SMT Wafer Pin: Brass/ Tin-plated  
SMT Wafer Fixed Foot: Brass/ Tin-plated

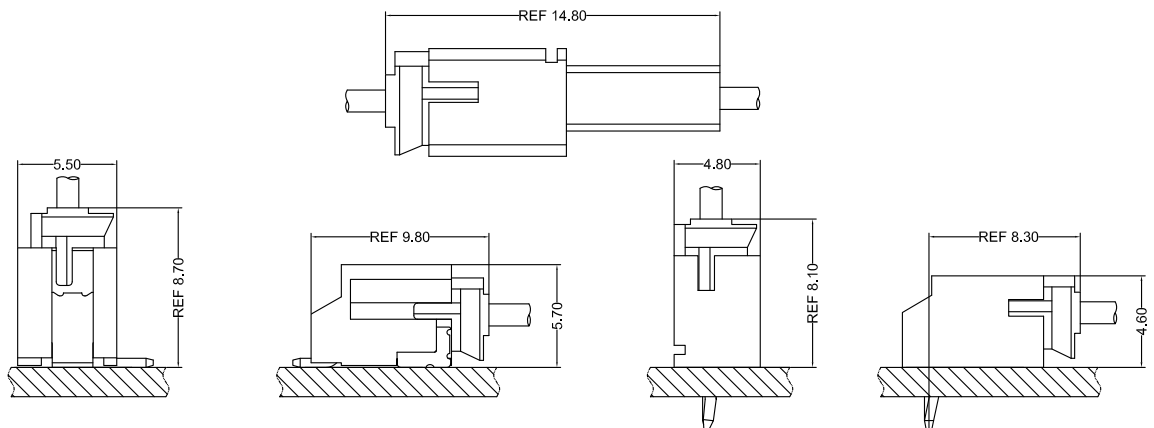

- Note: 1. The above figure is the figure viewed from the connector mounting side.  
2. Tolerances are non-cumulative:  $\pm 0.08$  mm for all centers.  
3. The dimensions above should serve as a guideline. Contact CSG for details.



# A2001 PH

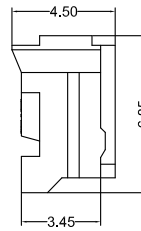
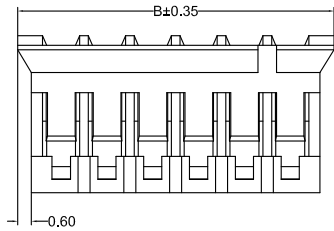
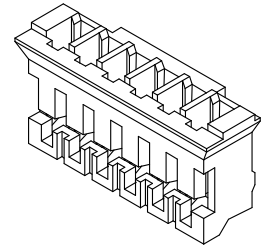
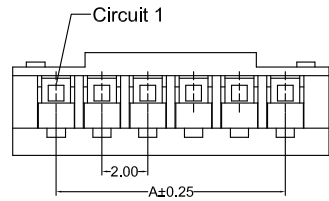

A2001HF 0XX AA P6 X 005  
 PIN 005=5PINS  
 SPECIAL AA=NO Special  
 Material P6=PA66 94V-0  
 Code 005  
 Color 9=White 0=Black

CSG PART NO.	Dimension mm		Q'ty/BAG
	A	B	
A2001HF002AAP6X005	2.00	5.80	1000PCS
A2001HF003AAP6X005	4.00	7.80	1000PCS
A2001HF004AAP6X005	6.00	9.80	1000PCS
A2001HF005AAP6X005	8.00	11.80	1000PCS
A2001HF006AAP6X005	10.00	13.80	1000PCS
A2001HF007AAP6X005	12.00	15.80	1000PCS
A2001HF008AAP6X005	14.00	17.80	1000PCS
A2001HF009AAP6X005	16.00	19.80	1000PCS
A2001HF010AAP6X005	18.00	21.80	1000PCS
A2001HF011AAP6X005	20.00	23.80	1000PCS
A2001HF012AAP6X005	22.00	25.80	1000PCS
A2001HF013AAP6X005	24.00	27.80	1000PCS
A2001HF014AAP6X005	26.00	29.80	1000PCS
A2001HF015AAP6X005	28.00	31.80	1000PCS
A2001HF016AAP6X005	30.00	33.80	1000PCS
A2001HF017AAP6X005	32.00	35.80	1000PCS
A2001HF018AAP6X005	34.00	37.80	1000PCS
A2001HF019AAP6X005	36.00	39.80	1000PCS
A2001HF020AAP6X005	38.00	41.80	1000PCS

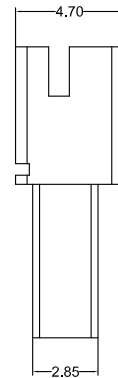
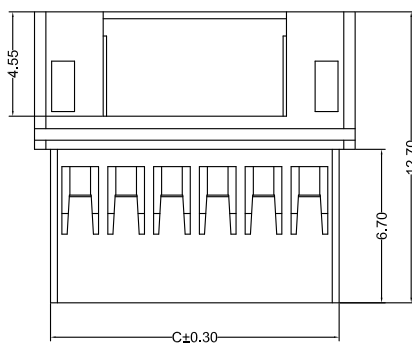
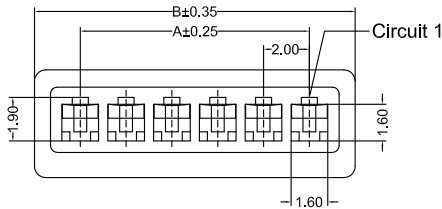

A2001HM 0XX AA P6 X 005  
 PIN 005=5PINS  
 SPECIAL AA=NO Special  
 Material P6=PA66 94V-0  
 Code 005  
 Color 9=White 0=Black

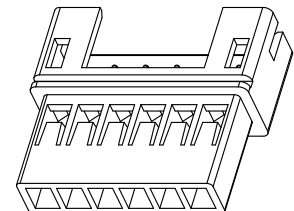

CSG PART NO.	Dimension mm			Q'ty/BAG
	A	B	C	
A2001HM002AAP6X005	2.00	8.00	4.60	1000PCS
A2001HM003AAP6X005	4.00	8.00	6.60	1000PCS
A2001HM004AAP6X005	6.00	10.00	8.60	1000PCS
A2001HM005AAP6X005	8.00	12.00	10.60	1000PCS
A2001HM006AAP6X005	10.00	14.00	12.60	1000PCS
A2001HM007AAP6X005	12.00	16.00	14.60	1000PCS
A2001HM008AAP6X005	14.00	18.00	16.60	1000PCS
A2001HM009AAP6X005	16.00	20.00	18.60	1000PCS
A2001HM010AAP6X005	18.00	22.00	20.60	1000PCS
A2001HM011AAP6X005	20.00	24.00	22.60	1000PCS
A2001HM012AAP6X005	22.00	26.00	24.60	1000PCS



# A2001 PH

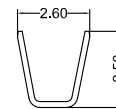
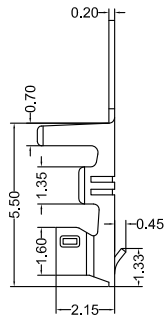
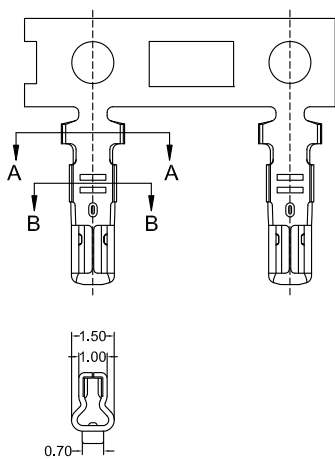

A2001 M 0 A TP 002

Type — M=Female Terminal

SPECIAL — O=NO Special

Material — A=Phosphor

Finish — TP=Tin-Plated

Code — 002

CSG PART NO.	Wire Range	Insulation O.D.	Q'ty/Reel
A2001M0ATP002	AWG#22-#30	1.50mm(max)	10000PCS

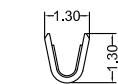
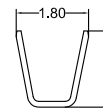
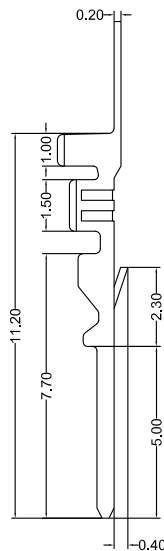
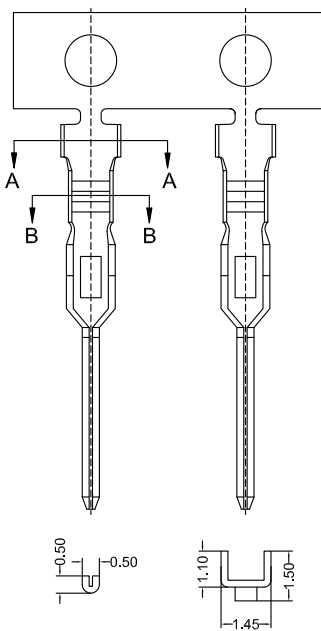

A2001 F 0 A TP 002

Type — F=Male Terminal

SPECIAL — O=NO Special

Material — A=Phosphor

Finish — TP=Tin-Plated

Code — 002

CSG PART NO.	Wire Range	Insulation O.D.	Q'ty/Reel
A2001F0ATP002	AWG#24-#30	1.50mm(max)	16000PCS



# A2001 PH

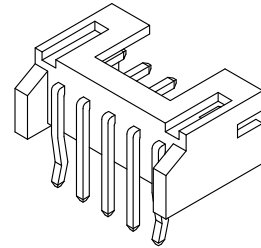
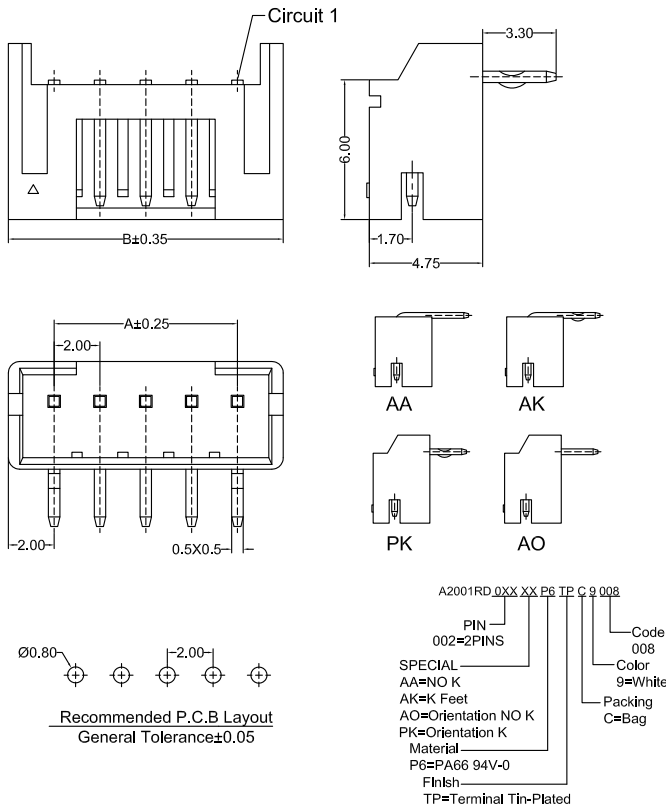

CSG PART NO.	Dimension mm		Q'ty/BAG
	A	B	
A2001RD002XXP6TPC9008	2.00	6.00	1000PCS
A2001RD003XXP6TPC9008	4.00	8.00	1000PCS
A2001RD004XXP6TPC9008	6.00	10.00	1000PCS
A2001RD005XXP6TPC9008	8.00	12.00	1000PCS
A2001RD006XXP6TPC9008	10.00	14.00	1000PCS
A2001RD007XXP6TPC9008	12.00	16.00	1000PCS
A2001RD008XXP6TPC9008	14.00	18.00	1000PCS
A2001RD009XXP6TPC9008	16.00	20.00	1000PCS
A2001RD010XXP6TPC9008	18.00	22.00	1000PCS
A2001RD011XXP6TPC9008	20.00	24.00	1000PCS
A2001RD012XXP6TPC9008	22.00	26.00	1000PCS
A2001RD013XXP6TPC9008	24.00	28.00	1000PCS
A2001RD014XXP6TPC9008	26.00	30.00	1000PCS
A2001RD015XXP6TPC9008	28.00	32.00	1000PCS
A2001RD016XXP6TPC9008	30.00	34.00	1000PCS
A2001RD017XXP6TPC9008	32.00	36.00	1000PCS
A2001RD018XXP6TPC9008	34.00	38.00	1000PCS
A2001RD019XXP6TPC9008	36.00	40.00	1000PCS
A2001RD020XXP6TPC9008	38.00	42.00	1000PCS

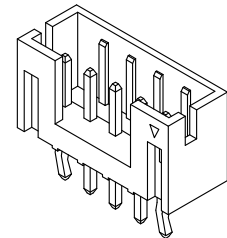
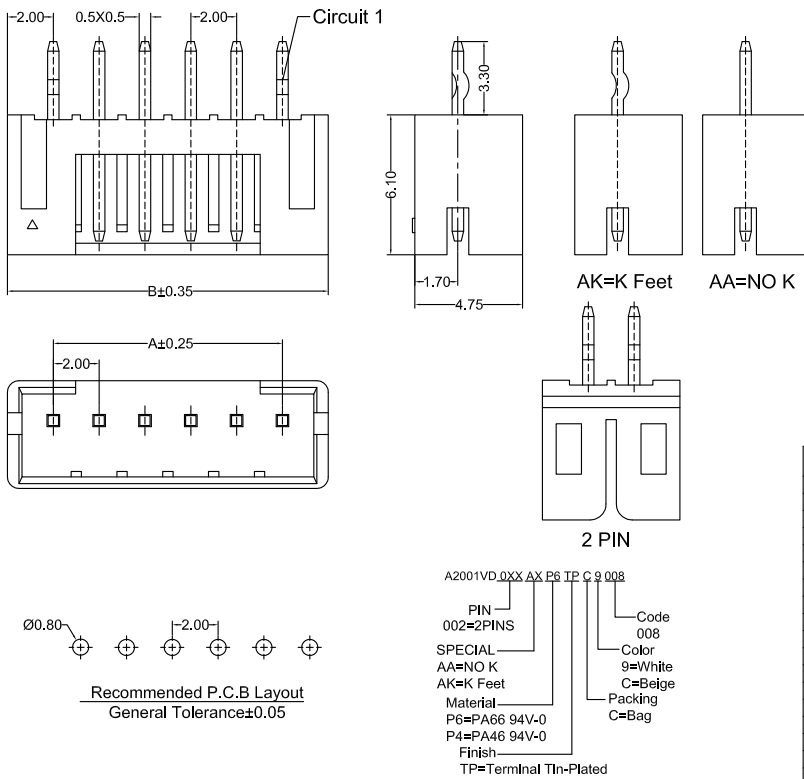

CSG PART NO.	Dimension mm		Q'ty/BAG
	A	B	
A2001VD002AXP7TPCX008	2.00	6.00	1000PCS
A2001VD003AXP7TPCX008	4.00	8.00	1000PCS
A2001VD004AXP7TPCX008	6.00	10.00	1000PCS
A2001VD005AXP7TPCX008	8.00	12.00	1000PCS
A2001VD006AXP7TPCX008	10.00	14.00	1000PCS
A2001VD007AXP7TPCX008	12.00	16.00	1000PCS
A2001VD008AXP7TPCX008	14.00	18.00	1000PCS
A2001VD009AXP7TPCX008	16.00	20.00	1000PCS
A2001VD010AXP7TPCX008	18.00	22.00	1000PCS
A2001VD011AXP7TPCX008	20.00	24.00	1000PCS
A2001VD012AXP7TPCX008	22.00	26.00	1000PCS
A2001VD013AXP7TPCX008	24.00	28.00	1000PCS
A2001VD014AXP7TPCX008	26.00	30.00	1000PCS
A2001VD015AXP7TPCX008	28.00	32.00	1000PCS
A2001VD016AXP7TPCX008	30.00	34.00	1000PCS
A2001VD017AXP7TPCX008	32.00	36.00	1000PCS
A2001VD018AXP7TPCX008	34.00	38.00	1000PCS
A2001VD019AXP7TPCX008	36.00	40.00	1000PCS
A2001VD020AXP7TPCX008	38.00	42.00	1000PCS

# A2001 PH

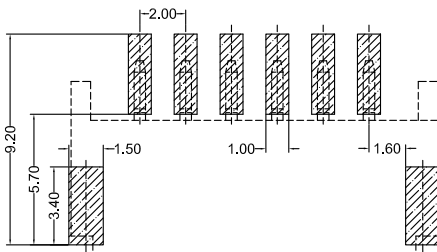
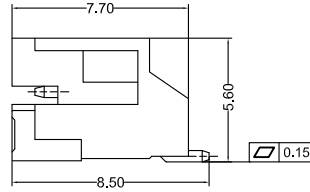
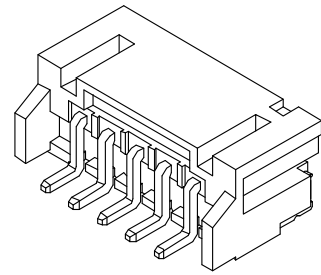
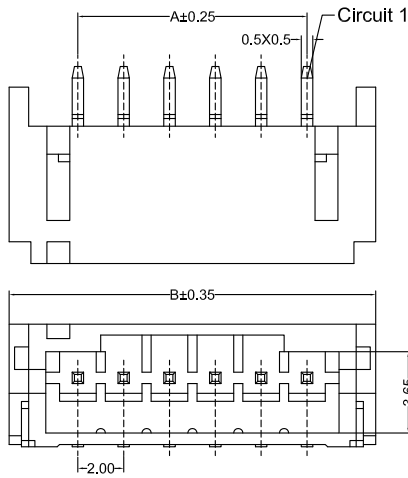

Recommended P.C.B Layout  
General Tolerance±0.05

A2001RS\_0XX AA LP TP B A 112

- PIN
- 002=2PINS
- SPECIAL
- AA=NO Special
- Material
- LP=LCP 94V-0
- Finish
- TP=Terminal Tin-Plated
- Code 112
- Color
- A=Natural
- Packing
- B=Tape & Reel

CSG PART NO.	Dimension mm		Q'ty/Reel
	A	B	
A2001RS002AALPTPBA112	2.00	8.00	1000PCS
A2001RS003AALPTPBA112	4.00	10.00	1000PCS
A2001RS004AALPTPBA112	6.00	12.00	1000PCS
A2001RS005AALPTPBA112	8.00	14.00	1000PCS
A2001RS006AALPTPBA112	10.00	16.00	1000PCS
A2001RS007AALPTPBA112	12.00	18.00	1000PCS
A2001RS008AALPTPBA112	14.00	20.00	1000PCS
A2001RS009AALPTPBA112	16.00	22.00	1000PCS
A2001RS010AALPTPBA112	18.00	24.00	1000PCS
A2001RS011AALPTPBA112	20.00	26.00	1000PCS
A2001RS012AALPTPBA112	22.00	28.00	1000PCS
A2001RS013AALPTPBA112	24.00	30.00	1000PCS
A2001RS014AALPTPBA112	26.00	32.00	1000PCS
A2001RS015AALPTPBA112	28.00	34.00	1000PCS
A2001RS016AALPTPBA112	30.00	36.00	1000PCS

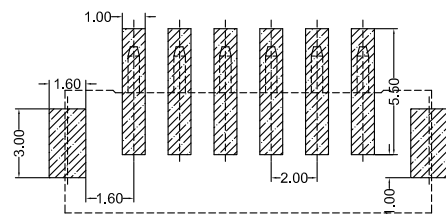
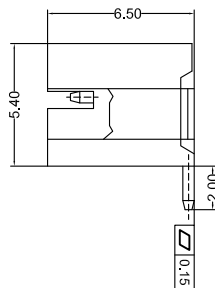
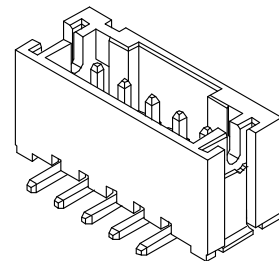
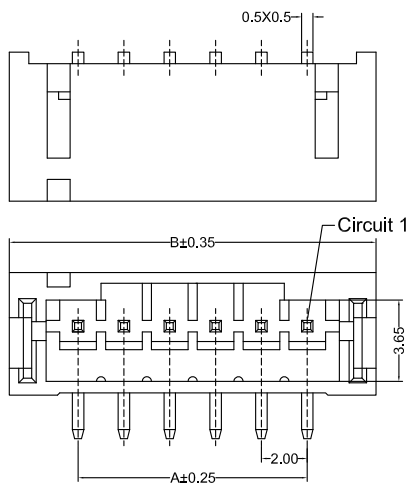

Recommended P.C.B Layout  
General Tolerance±0.05

A2001VS\_0XX AA LP TP B A 112

- PIN
- 002=2PINS
- SPECIAL
- AA=NO Special
- Material
- LP=LCP 94V-0
- Finish
- TP=Terminal Tin-Plated
- Code 112
- Color
- A=Natural
- Packing
- B=Tape & Reel

CSG PART NO.	Dimension mm		Q'ty/Reel
	A	B	
A2001VS002AALPTPBA112	2.00	8.00	700PCS
A2001VS003AALPTPBA112	4.00	10.00	700PCS
A2001VS004AALPTPBA112	6.00	12.00	700PCS
A2001VS005AALPTPBA112	8.00	14.00	700PCS
A2001VS006AALPTPBA112	10.00	16.00	700PCS
A2001VS007AALPTPBA112	12.00	18.00	700PCS
A2001VS008AALPTPBA112	14.00	20.00	700PCS
A2001VS009AALPTPBA112	16.00	22.00	700PCS
A2001VS010AALPTPBA112	18.00	24.00	700PCS
A2001VS011AALPTPBA112	20.00	26.00	700PCS
A2001VS012AALPTPBA112	22.00	28.00	700PCS
A2001VS013AALPTPBA112	24.00	30.00	700PCS
A2001VS014AALPTPBA112	26.00	32.00	700PCS
A2001VS015AALPTPBA112	28.00	34.00	700PCS
A2001VS016AALPTPBA112	30.00	36.00	700PCS

