

C3002 44133 CONNECTOR

3.00mm Pitch/Disconnectable Crimp style connectors

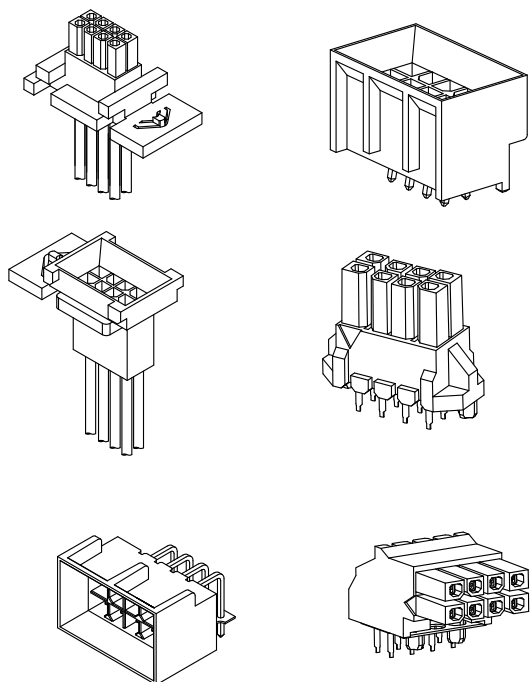

- Secure locking structure
- Low insertion force
- Suction area for picking up
- Improvement of engagement with prying

Specifications:

- Current rating: 5.0 A / AC,DC
- Voltage rating: 250 V AC/DC
- Temperature range: -40°C ~ +105°C
(including temperature rise in applying electrical current)
- Contact resistance: Initial value/ 20m Ω max
Insulation resistance: 1000 M Ω min
Withstanding voltage: 1500 VAC/minute
Applicable wire: Conductor size/ AWG#24~#16
Insulation O.D./ 1.30 to 2.05 mm
- * Compliant with RoHS2/ REACH
- * Refer to "General Instruction and Notice when using Terminals and Connectors"
- * Contact CSG for details

Material:

Housing: PA66/UL94-V0;Color:Black
Terminal: Phosphor/Brass C1100/ Gold-Plated/ Tin-plated
DIP Wafer Housing: PA9T,UL94-V0;Color:Black
DIP Wafer Pin: Phosphor Tin-plated/ Gold-Plated

- Note: 1. The above figure is the figure viewed from the connector mounting side.
2. Tolerances are non-cumulative: ±0.08 mm for all centers.
3. The dimensions above should serve as a guideline. Contact CSG for details.

CSG

C3002 44133

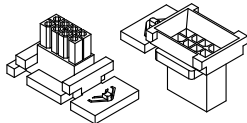

C3002HX

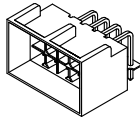
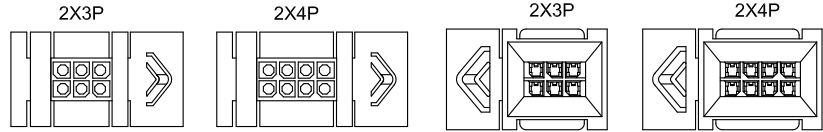

C3002RD2XXAL

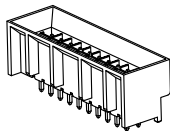
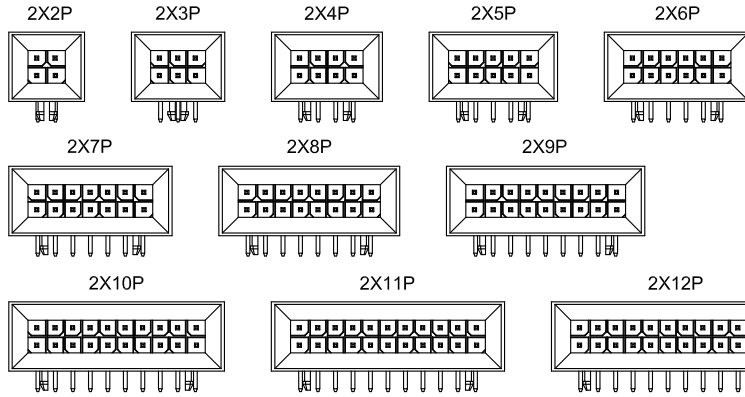

C3002VD2XXAL

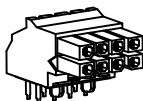
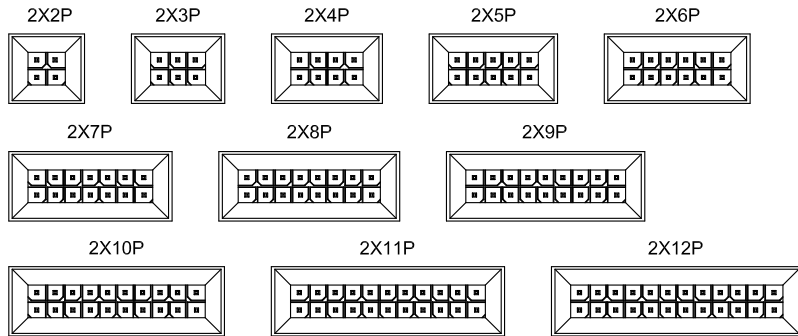

C3002RD2XXAM

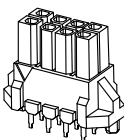
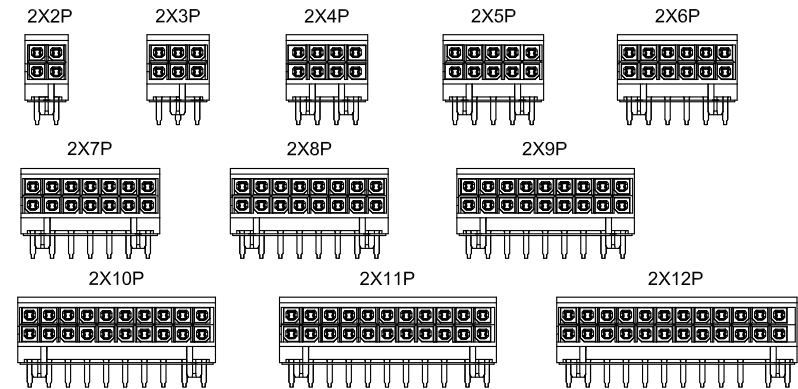

C3002VD2XXAM

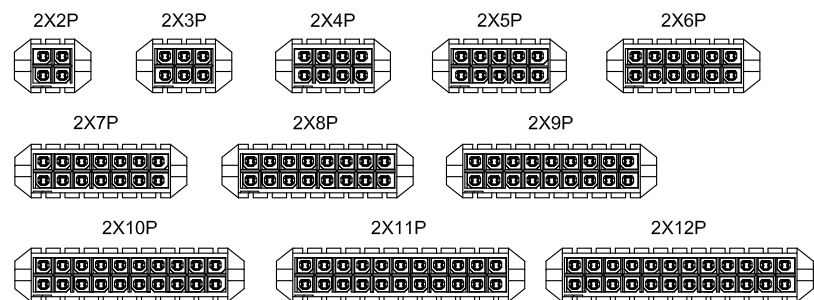

C3002 44133

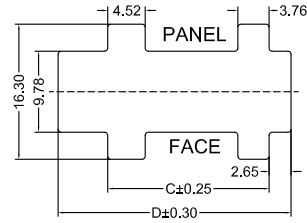
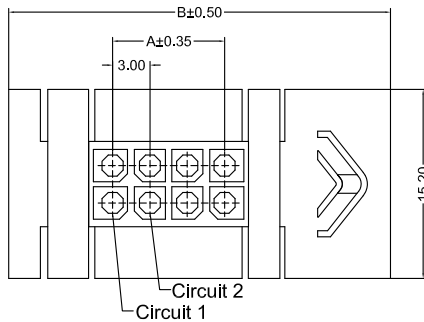

PANEL OPENING
RECOMMENDED PANEL THICKNESS
1.57/1.27

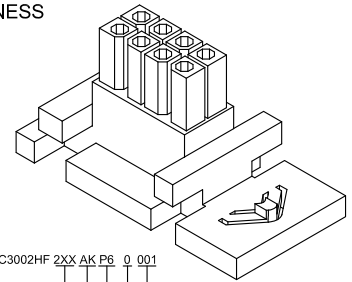
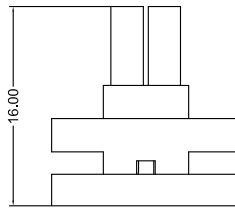
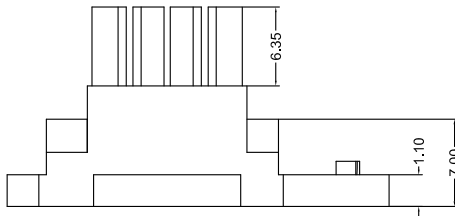

C3002HF 2XX AK P6 0 001
 PIN 203=2X3PINS
 SPECIAL AK=BUCKLE
 Material P6=PA66 94V-0
 Code 001
 Color 0=Black

CSG PART NO.	Dimension mm				Q'ty/BAG
	A	B	C	D	
C3002HF203AKP60001	6.00	27.80	16.46	25.10	1000PCS
C3002HF204AKP60001	9.00	30.80	19.46	28.10	1000PCS

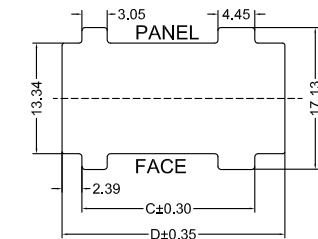
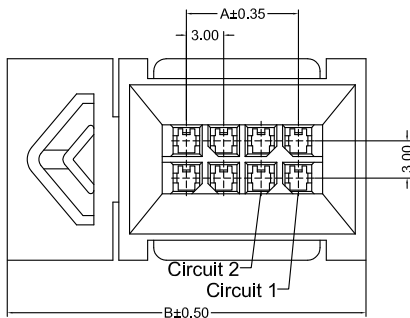

PANEL OPENING
RECOMMENDED PANEL THICKNESS
1.57/1.27

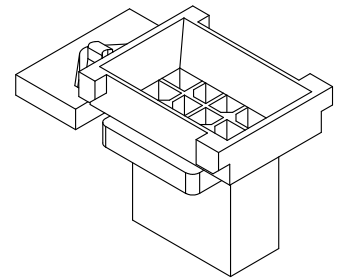
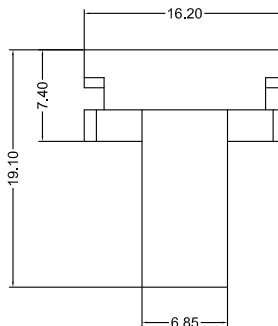
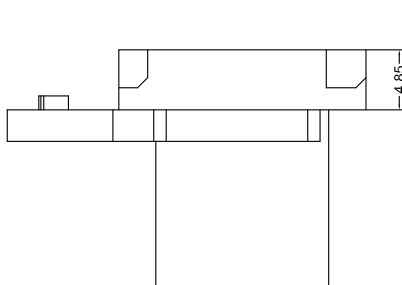

C3002HM 2XX AK P6 0 001
 PIN 203=2X3PINS
 SPECIAL AK=BUCKLE
 Material P6=PA66 94V-0
 Code 001
 Color 0=Black

CSG PART NO.	Dimension mm				Q'ty/BAG
	A	B	C	D	
C3002HM203AKP60001	6.00	25.85	17.85	23.85	1000PCS
C3002HM204AKP60001	9.00	28.85	20.85	26.85	1000PCS



C3002 44133

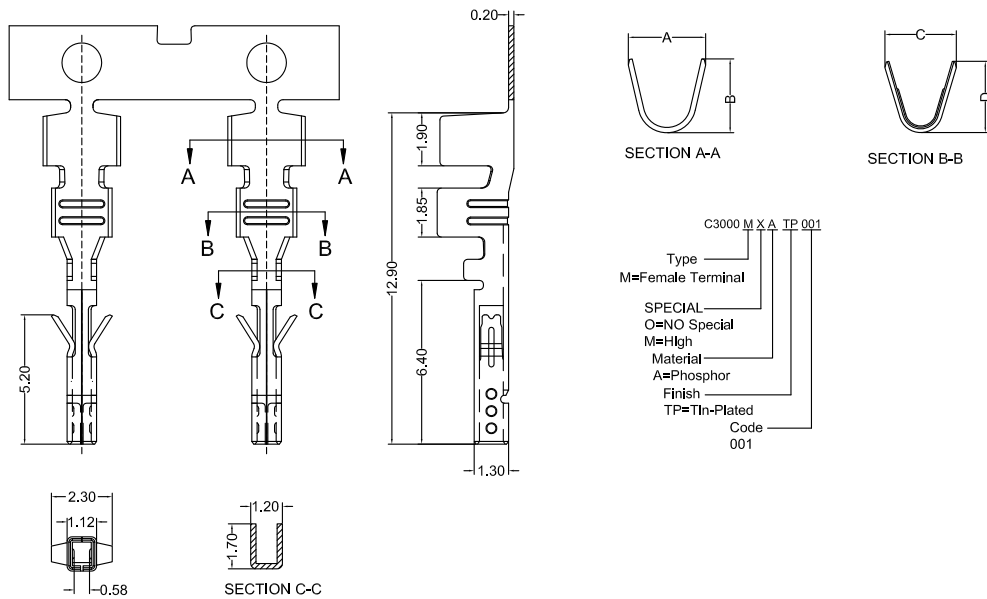

CSG PART NO.	A	B	C	C	Wire Range	Insulation O.D.	Q'ty/Reel
C3000MOATP001	2.60	2.60	2.10	2.10	AWG#20-#24	1.85mm(max)	10000PCS
C3000MMAGF001	2.90	2.80	2.70	2.70	AWG#16-#20	2.05mm(max)	10000PCS

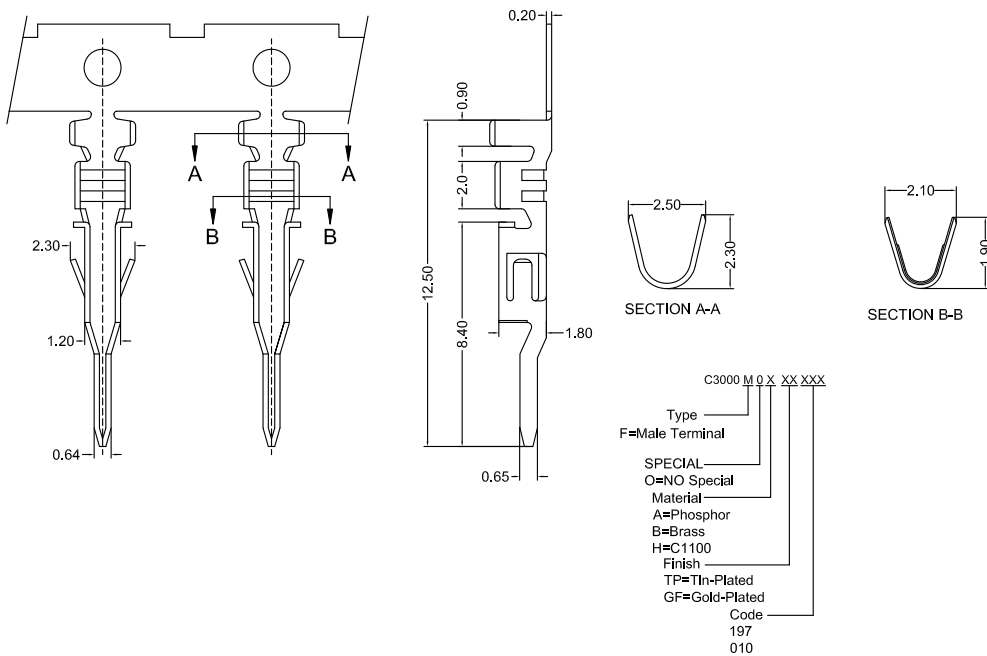

CSG PART NO.	Wire Range	Insulation O.D.	Q'ty/Reel
C3000F0XTPXXX	AWG#20-#24	1.85mm(max)	10000PCS
C3000F0XGFXXX	AWG#20-#24	1.85mm(max)	10000PCS



C3002 44133

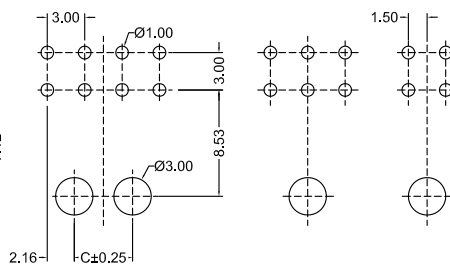
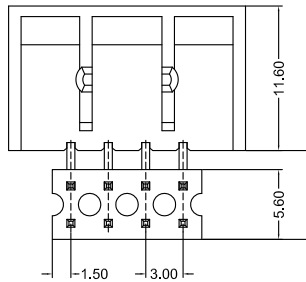
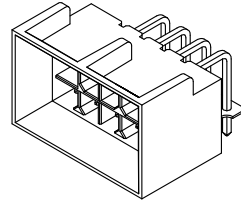
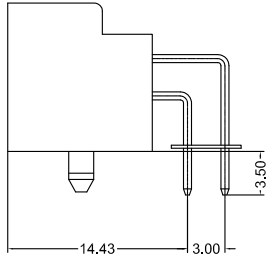
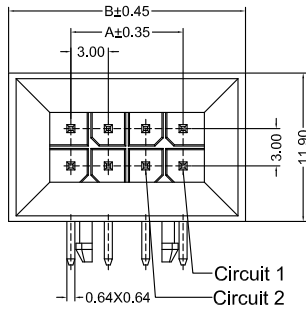

Recommended P.C.B Layout
General Tolerance±0.05

C3002RD 2XX AL 9T XX 0 010
 PIN
 205=2X5PINS
 SPECIAL
 AL=Bell mouth mother seat
 Material
 9T=PA9T 94-V0
 Finish
 TP=Tin Plated
 GF=Gold-Plated
 G2=15U Gold-Plated
 Code
 010
 Color
 0=Black
 Packing
 D=Box Packing

CSG PART NO.	Dimension mm			Q'ty
	A	B	C	
C3002RD202AL9TXXD0010	3.00	13.00	11.90	1000PCS
C3002RD203AL9TXXD0010	6.00	16.00	11.90	1000PCS
C3002RD204AL9TXXD0010	9.00	19.00	4.68	1000PCS
C3002RD205AL9TXXD0010	12.00	22.00	7.68	1000PCS
C3002RD206AL9TXXD0010	15.00	25.00	10.68	1000PCS
C3002RD207AL9TXXD0010	18.00	28.00	13.68	1000PCS
C3002RD208AL9TXXD0010	21.00	31.00	16.68	1000PCS
C3002RD209AL9TXXD0010	24.00	34.00	19.68	1000PCS
C3002RD210AL9TXXD0010	27.00	37.00	22.68	1000PCS
C3002RD211AL9TXXD0010	30.00	40.00	25.68	1000PCS
C3002RD212AL9TXXD0010	33.00	43.00	28.68	1000PCS

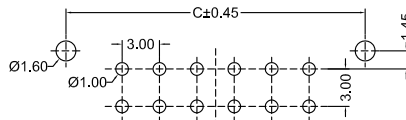
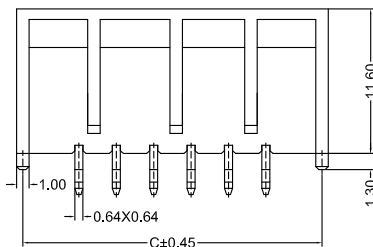
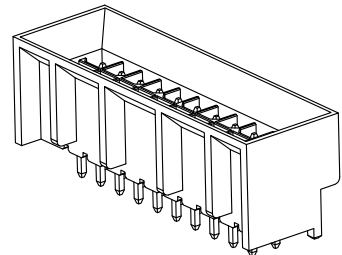
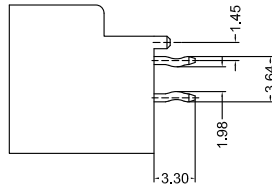
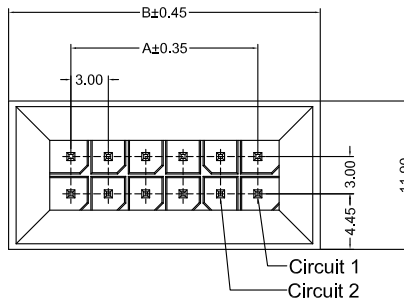

Recommended P.C.B Layout
General Tolerance±0.05

C3002VD 2XX AL 9T XX C 0 010
 PIN
 205=2X5PINS
 SPECIAL
 AL=Bell mouth mother seat
 Material
 9T=PA9T 94-V0
 Finish
 TP=Tin Plated
 GF=Gold-Plated
 G2=15U Gold-Plated
 Code
 010
 Color
 0=Black
 Packing
 C=PE Bag

CSG PART NO.	Dimension mm			Q'ty
	A	B	C	
C3002VD202AL9TXXC0010	3.00	13.00	12.00	1000PCS
C3002VD203AL9TXXC0010	6.00	16.00	15.00	1000PCS
C3002VD204AL9TXXC0010	9.00	19.00	18.00	1000PCS
C3002VD205AL9TXXC0010	12.00	22.00	21.00	1000PCS
C3002VD206AL9TXXC0010	15.00	25.00	24.00	1000PCS
C3002VD207AL9TXXC0010	18.00	28.00	27.00	1000PCS
C3002VD208AL9TXXC0010	21.00	31.00	30.00	1000PCS
C3002VD209AL9TXXC0010	24.00	34.00	33.00	1000PCS
C3002VD210AL9TXXC0010	27.00	37.00	36.00	1000PCS
C3002VD211AL9TXXC0010	30.00	40.00	39.00	1000PCS
C3002VD212AL9TXXC0010	33.00	43.00	42.00	1000PCS



C3002 44133

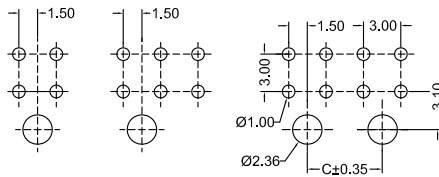
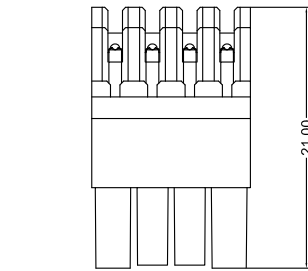

Recommended P.C.B Layout
General Tolerance±0.05

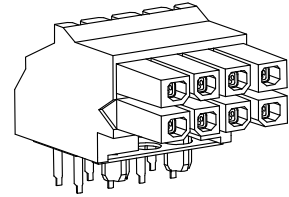
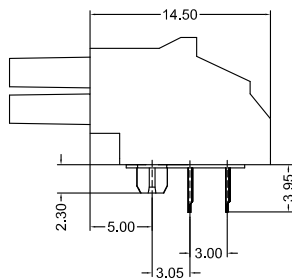
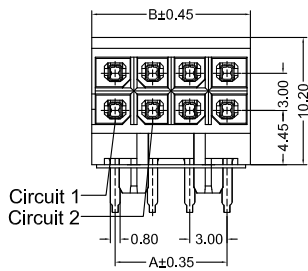

C3002RD 2XX AM 9T XX D 0 010
 PIN
 205=2X5PINS
 SPECIAL
 AM= Bell seat
 Material
 9T=PA9T 94-V0
 Finish
 TP=Tin Plated
 GF=Gold-Plated
 G2=15U Gold-Plated
 Code
 010
 Color
 0=Black
 Packing
 D=Box Packing

CSG PART NO.	Dimension mm			Q'ty
	A	B	C	
C3002RD202AM9TXXD0010	3.00	6.70	9.00	1000PCS
C3002RD203AM9TXXD0010	6.00	9.70	12.00	1000PCS
C3002RD204AM9TXXD0010	9.00	12.70	15.00	1000PCS
C3002RD205AM9TXXD0010	12.00	15.70	18.00	1000PCS
C3002RD206AM9TXXD0010	15.00	18.70	21.00	1000PCS
C3002RD207AM9TXXD0010	18.00	21.70	24.00	1000PCS
C3002RD208AM9TXXD0010	21.00	24.70	27.00	1000PCS
C3002RD209AM9TXXD0010	24.00	27.70	30.00	1000PCS
C3002RD210AM9TXXD0010	27.00	30.70	33.00	1000PCS
C3002RD211AM9TXXD0010	30.00	33.70	36.00	1000PCS
C3002RD212AM9TXXD0010	33.00	36.70	39.00	1000PCS

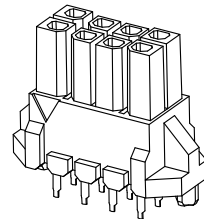
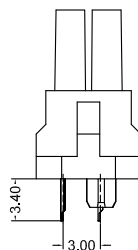
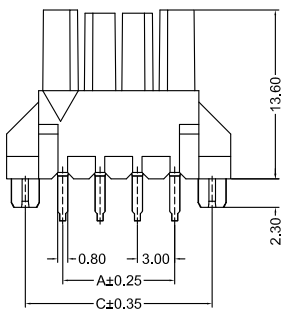
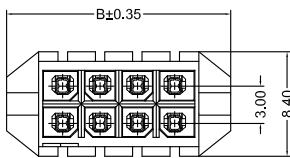

C3002VD 2XX AM 9T XX A 0 010
 PIN
 205=2X5PINS
 SPECIAL
 AM= Bell seat
 Material
 9T=PA9T 94-V0
 Finish
 TP=Tin Plated
 GF=Gold-Plated
 G2=15U Gold-Plated
 Code
 010
 Color
 0=Black
 Packing
 A=TUBE Packing

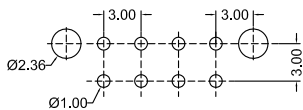

Recommended P.C.B Layout
General Tolerance±0.05

CSG PART NO.	Dimension mm			Q'ty
	A	B	C	
C3002VD202AM9TXXA0010	3.00	12.00	9.00	1000PCS
C3002VD203AM9TXXA0010	6.00	15.00	12.00	1000PCS
C3002VD204AM9TXXA0010	9.00	18.00	15.00	1000PCS
C3002VD205AM9TXXA0010	12.00	21.00	18.00	1000PCS
C3002VD206AM9TXXA0010	15.00	24.00	21.00	1000PCS
C3002VD207AM9TXXA0010	18.00	27.00	24.00	1000PCS
C3002VD208AM9TXXA0010	21.00	30.00	27.00	1000PCS
C3002VD209AM9TXXA0010	24.00	33.00	30.00	1000PCS
C3002VD210AM9TXXA0010	27.00	36.00	33.00	1000PCS
C3002VD211AM9TXXA0010	30.00	39.00	36.00	1000PCS
C3002VD212AM9TXXA0010	33.00	42.00	39.00	1000PCS

