

A1504 504051 CONNECTOR

1.50mm Pitch/Disconnectable Crimp style connectors

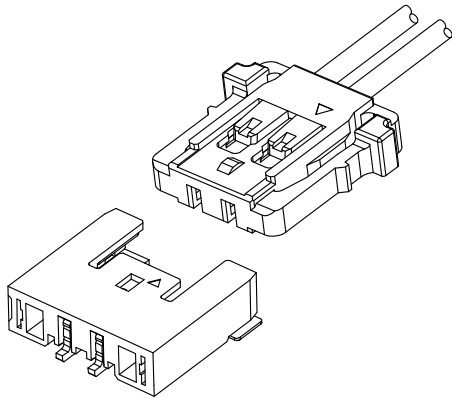

- Secure locking structure
- Low insertion force
- Suction area for picking up
- Improvement of engagement with prying

Specifications:

- Current rating: 3.0 A / AC,DC
- Voltage rating: 150 V AC/DC
- Temperature range: -25°C ~ +105°C
(including temperature rise in applying electrical current)
- Contact resistance: Initial value/ 20m Ω max
Insulation resistance: 1000 MΩ min
Withstanding voltage: 500 VAC/minute
Applicable wire: Conductor size/ AWG#28~#24
Insulation O.D./ 0.60 to 1.10 mm
- * Compliant with RoHS2/ REACH
- * Refer to "General Instruction and Notice when using Terminals and Connectors"
- * Contact CSG for details

Material:

Housing: PA66/UL94-V0;Color:Black
Terminal: Phosphor/ Tin-plated/ Gold-Plated
Wafer Housing: PA4T,UL94-V0;Color:Black
Wafer Pin: Brass/ Gold-Plated
Wafer Fixed Foot: Brass/ Tin-plated

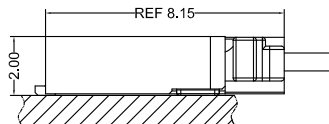

- Note: 1. The above figure is the figure viewed from the connector mounting side.
2. Tolerances are non-cumulative: ± 0.08 mm for all centers.
3. The dimensions above should serve as a guideline. Contact CSG for details.

CSG

A1504 504051

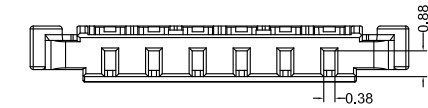
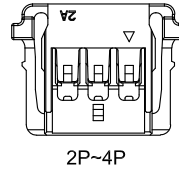
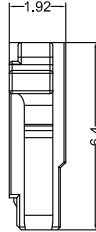
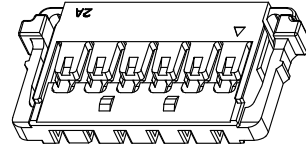
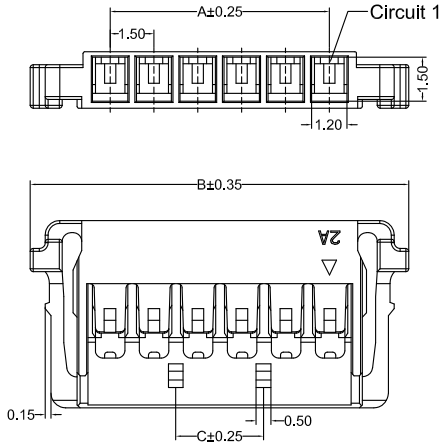

A1504HF 0XX AA P6 0 109
 PIN
 005=5PINS
 SPECIAL
 AA=NO Special
 Material
 P6=PA66 94V-0
 Code
 109
 Color
 0=Black

CSG PART NO.	Dimension mm			Q'ty/BAG
	A	B	C	
A1504HF002AAP60109	1.50	6.95		1000PCS
A1504HF003AAP60109	3.00	8.45		1000PCS
A1504HF004AAP60109	4.50	9.95		1000PCS
A1504HF005AAP60109	6.00	11.45	3.00	1000PCS
A1504HF006AAP60109	7.50	12.95	3.00	1000PCS
A1504HF007AAP60109	9.00	14.45	4.50	1000PCS
A1504HF008AAP60109	10.50	15.95	6.00	1000PCS
A1504HF009AAP60109	12.00	17.45	7.50	1000PCS
A1504HF010AKP69109	13.50	18.95	9.00	1000PCS
A1504HF011AAP60109	15.00	20.45	10.50	1000PCS
A1504HF012AAP60109	16.50	21.95	12.00	1000PCS

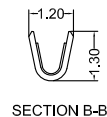
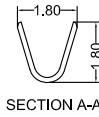
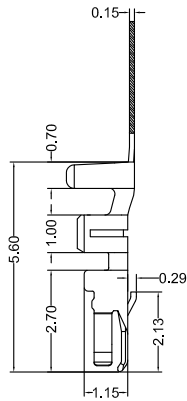
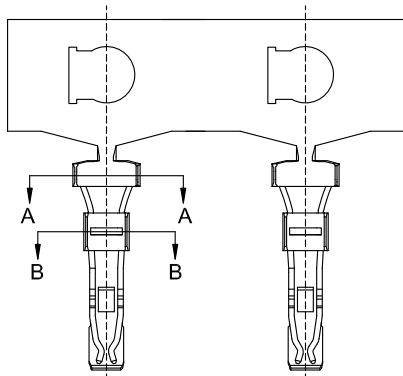

A1504 M 0 Δ XX 109
 Type
 M=Female Terminal
 SPECIAL
 0=NO Special
 Material
 A=Phosphor
 Finish
 TP=Tin-Plated
 GF=Gold-Plated/GF
 Code
 109

CSG PART NO.	Wire Range	Insulation O.D.	Q'ty/Reel
A1504M0ATP109	AWG#24~#28	1.10mm(max)	10000PCS
A1504M0AGF109	AWG#24~#28	1.10mm(max)	10000PCS



A1504 504051

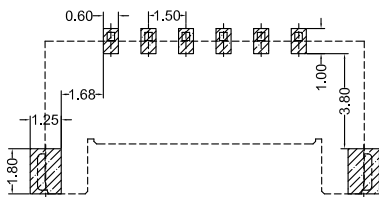
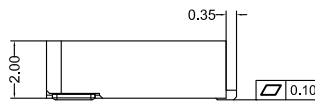
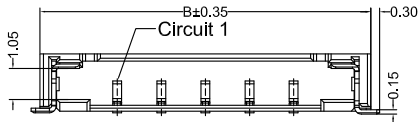
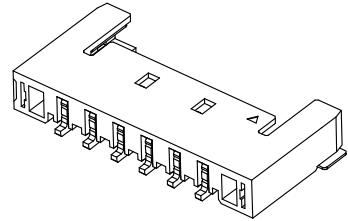
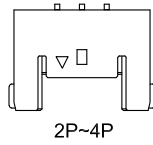
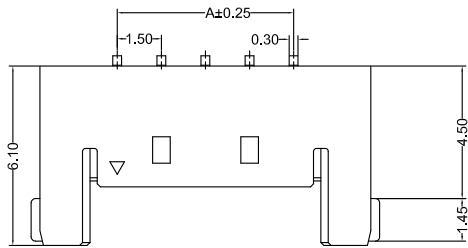

Recommended P.C.B Layout
General Tolerance±0.05

A1504RS.DXX AA 4T GF B C 109

- PIN
- 002=2PINS
- SPECIAL
- AA=NO Special
- Material
- 4T=PA4T 94V-0
- Finish
- GF=Gold-Plated/GF
- Code
- 109
- Color
- 0=Black
- Packing
- B=Tape & Reel

CSG PART NO.	Dimension mm		Q'ty/Reel
	A	B	
A1504RS002AA4TGFB0109	1.50	6.75	2000PCS
A1504RS003AA4TGFB0109	3.00	8.25	2000PCS
A1504RS004AA4TGFB0109	4.50	9.75	2000PCS
A1504RS005AA4TGFB0109	6.00	11.25	2000PCS
A1504RS006AA4TGFB0109	7.50	12.75	2000PCS
A1504RS007AA4TGFB0109	9.00	14.25	2000PCS
A1504RS008AA4TGFB0109	10.50	15.75	2000PCS
A1504RS009AA4TGFB0109	12.00	17.25	2000PCS
A1504RS010AA4TGFB0109	13.50	18.75	2000PCS
A1504RS011AA4TGFB0109	15.00	20.25	2000PCS
A1504RS012AA4TGFB0109	16.50	21.75	2000PCS

