

A2505 XHB CONNECTOR

2.50mm Pitch/Disconnectable Crimp style connectors

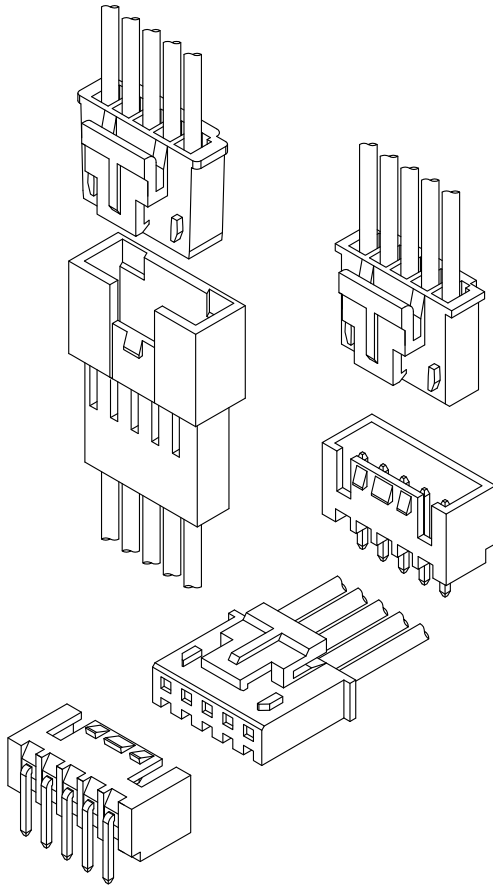

- Secure locking structure
- Low insertion force
- Suction area for picking up
- Improvement of engagement with prying

Specifications:

- Current rating: 2.5 A / AC,DC (AWG #22)
- Voltage rating: 250 V AC/DC
- Temperature range: -25°C ~ +105°C
(including temperature rise in applying electrical current)
- Contact resistance: Initial value/ 20m Ω max
Insulation resistance: 1000 MΩ min
Withstanding voltage: 1000 VAC/minute
Applicable wire: Conductor size/ AWG#28~#22
Insulation O.D./ 0.80 to 1.90 mm

- * Compliant with RoHS2/ REACH
- * Refer to "General Instruction and Notice when using Terminals and Connectors"
- * Contact CSG for details

Material:

Housing: PA66/UL94-V0;Color:White
Terminal: Phosphor/ Tin-plated
DIP Wafer Housing: PA66,UL94-V0;Color:White
DIP Wafer Pin: Brass/ Tin-plated
SMT Wafer Housing: LCP,UL94-V0;Color:Gray
SMT Wafer Pin: Brass/ Tin-plated
SMT Wafer Fixed Foot: Brass/ Tin-plated

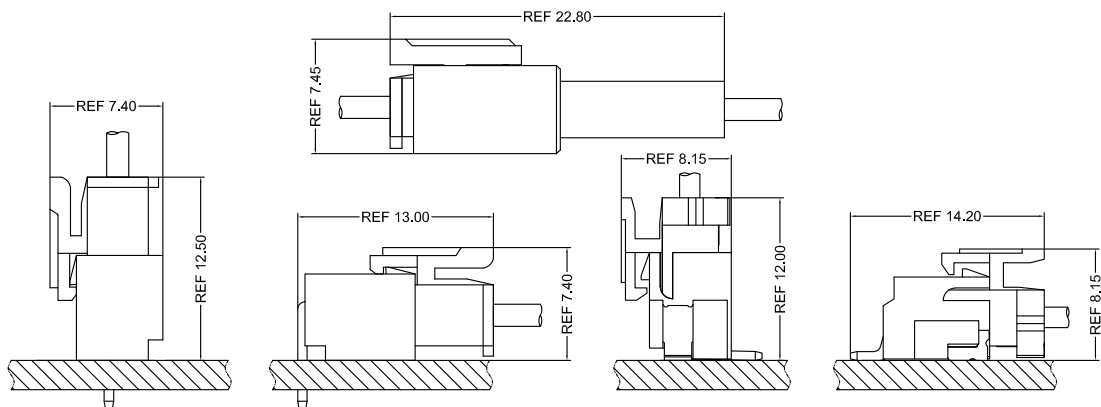

- Note: 1. The above figure is the figure viewed from the connector mounting side.
2. Tolerances are non-cumulative: ± 0.08 mm for all centers.
3. The dimensions above should serve as a guideline. Contact CSG for details.

CSG

A2505 XHB

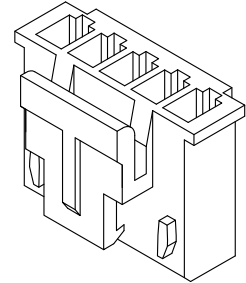
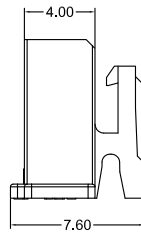
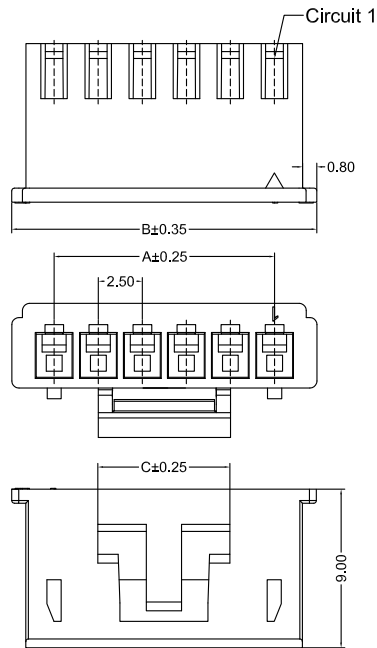

A2505HF 0XX AK P6 9 007
 PIN 005=5PINS
 SPECIAL: AK=BUCKLE
 Material P6=PA66 94V-0
 Code 007
 Color 9=White

CSG PART NO.	Dimension mm			Q'ty/BAG
	A	B	C	
A2505HF002AKP69007	2.50	5.70	3.00	1000PCS
A2505HF003AKP69007	5.00	8.20	4.00	1000PCS
A2505HF004AKP69007	7.50	10.70	5.00	1000PCS
A2505HF005AKP69007	10.00	13.20	7.50	1000PCS
A2505HF006AKP69007	12.50	15.70	10.00	1000PCS
A2505HF007AKP69007	15.00	18.20	12.50	1000PCS
A2505HF008AKP69007	17.50	20.70	12.50	1000PCS
A2505HF009AKP69007	20.00	23.20	12.50	1000PCS
A2505HF010AKP69007	22.50	25.70	12.50	1000PCS
A2505HF011AKP69007	25.00	28.20	12.50	1000PCS
A2505HF012AKP69007	27.50	30.70	12.50	1000PCS
A2505HF013AKP69007	30.00	33.20	12.50	1000PCS
A2505HF014AKP69007	32.50	35.70	12.50	1000PCS
A2505HF015AKP69007	35.00	38.20	12.50	1000PCS
A2505HF016AKP69007	37.50	40.70	12.50	1000PCS

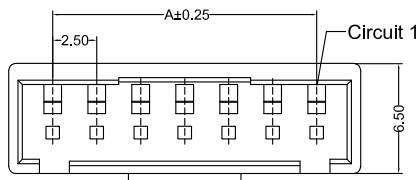
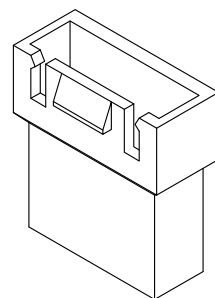
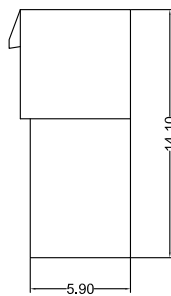
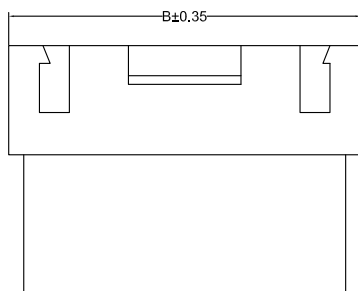

A2505HM 0XX AK P6 9 007
 PIN 005=5PINS
 SPECIAL: AA=NO Special
 Material P6=PA66 94V-0
 Code 007
 Color 9=White

CSG PART NO.	Dimension mm		Q'ty/BAG
	A	B	
A2505HM002AAP69007	2.50	7.50	1000PCS
A2505HM003AAP69007	5.00	10.00	1000PCS
A2505HM004AAP69007	7.50	12.50	1000PCS
A2505HM005AAP69007	10.00	15.00	1000PCS
A2505HM006AAP69007	12.50	17.50	1000PCS
A2505HM007AAP69007	15.00	20.00	1000PCS
A2505HM008AAP69007	17.50	22.50	1000PCS
A2505HM009AAP69007	20.00	25.00	1000PCS
A2505HM010AAP69007	22.50	27.50	1000PCS
A2505HM011AAP69007	25.00	30.00	1000PCS
A2505HM012AAP69007	27.50	32.50	1000PCS
A2505HM013AAP69007	30.00	35.00	1000PCS
A2505HM014AAP69007	32.50	37.50	1000PCS
A2505HM015AAP69007	35.00	40.00	1000PCS
A2505HM016AAP69007	37.50	42.50	1000PCS



A2505 XHB

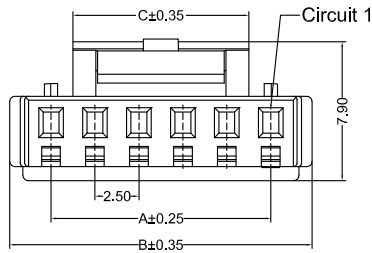
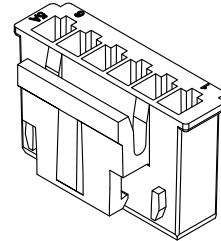
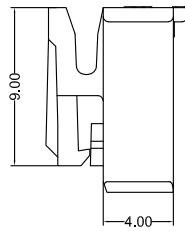
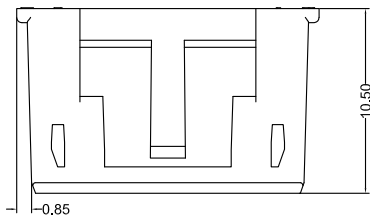

A2505HF 0XX AK P6 9 008
 PIN 005=5PINS
 SPECIAL AK=BUCKLE
 Material P6=PA66 94V-0
 Code 008
 Color 9=White

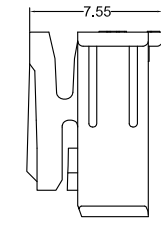
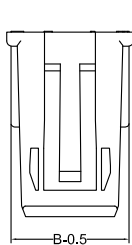

2P~3P

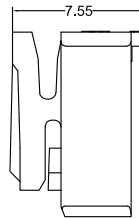
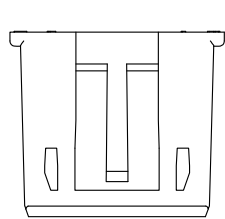

4P~5P

CSG PART NO.	Dimension mm			Q'ty/BAG
	A	B	C	
A2505HF002AKP69008	2.50	7.20	3.00	1000PCS
A2505HF003AKP69008	5.00	9.70	3.00	1000PCS
A2505HF004AKP69008	7.50	12.20	4.80	1000PCS
A2505HF005AKP69008	10.00	14.70	4.80	1000PCS
A2505HF006AKP69008	12.50	17.20	10.00	1000PCS
A2505HF007AKP69008	15.00	19.70	10.00	1000PCS
A2505HF008AKP69008	17.50	21.20	12.50	1000PCS
A2505HF009AKP69008	20.00	24.70	12.50	1000PCS
A2505HF010AKP69008	22.50	27.20	15.00	1000PCS
A2505HF011AKP69008	25.00	29.70	15.00	1000PCS
A2505HF012AKP69008	27.50	31.20	17.50	1000PCS
A2505HF013AKP69008	30.00	34.70	17.50	1000PCS
A2505HF014AKP69008	32.50	37.20	17.50	1000PCS
A2505HF015AKP69008	35.00	39.70	17.50	1000PCS

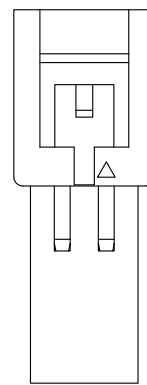
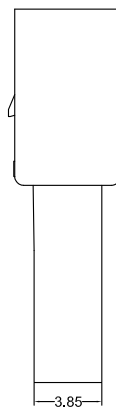
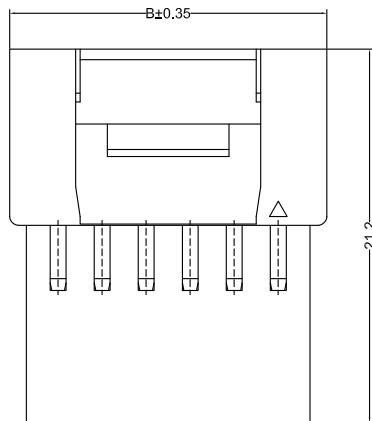

2P~3P

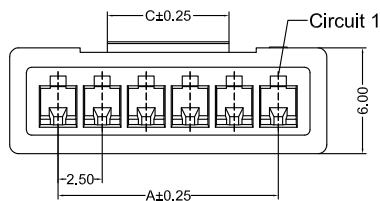

A2505HM 0XX AK P6 9 008
 PIN 005=5PINS
 SPECIAL AA=NO Special
 Material P6=PA66 94V-0
 Code 008
 Color 9=White

CSG PART NO.	Dimension mm			Q'ty/BAG
	A	B	C	
A2505HM002AAP69008	2.50	8.00	1.00	1000PCS
A2505HM003AAP69008	5.00	10.50	1.00	1000PCS
A2505HM004AAP69008	7.50	13.00	1.90	1000PCS
A2505HM005AAP69008	10.00	15.50	1.90	1000PCS
A2505HM006AAP69008	12.50	18.00	6.90	1000PCS
A2505HM007AAP69008	15.00	20.50	9.40	1000PCS
A2505HM008AAP69008	17.50	23.00	11.90	1000PCS
A2505HM009AAP69008	20.00	25.50	14.40	1000PCS
A2505HM010AAP69008	22.50	28.00	16.90	1000PCS
A2505HM011AAP69008	25.00	30.50	19.40	1000PCS
A2505HM012AAP69008	27.50	33.00	21.90	1000PCS
A2505HM013AAP69008	30.00	35.50	24.40	1000PCS
A2505HM014AAP69008	32.50	38.00	26.90	1000PCS
A2505HM015AAP69008	35.00	40.50	29.40	1000PCS



A2505 XHB

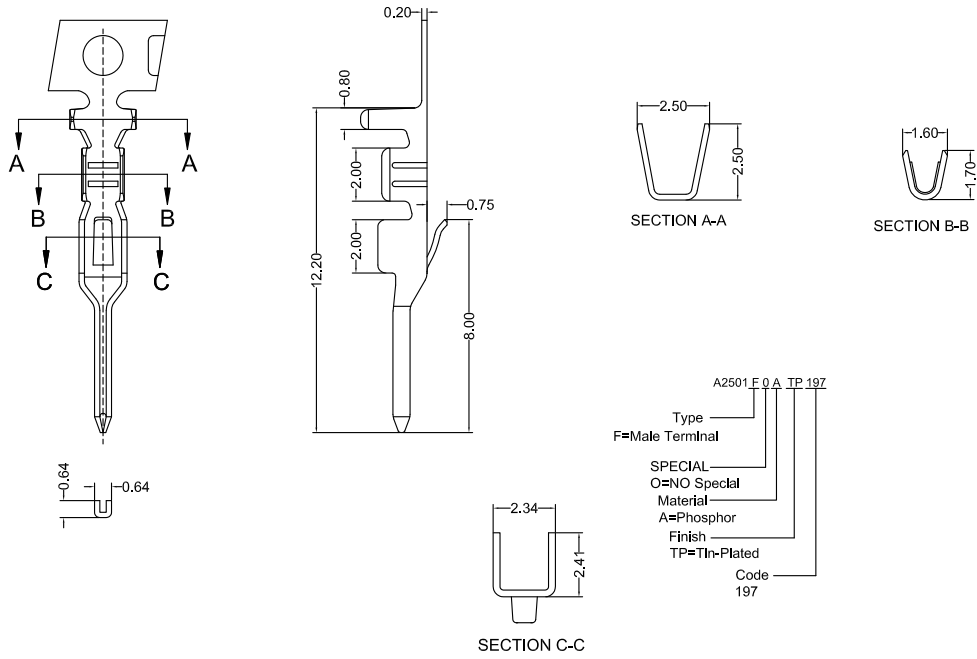

CSG PART NO.	Wire Range	Insulation O.D.	Q'ty/Reel
A2501F0ATP197	AWG#22-#28	1.80mm(max)	8000PCS

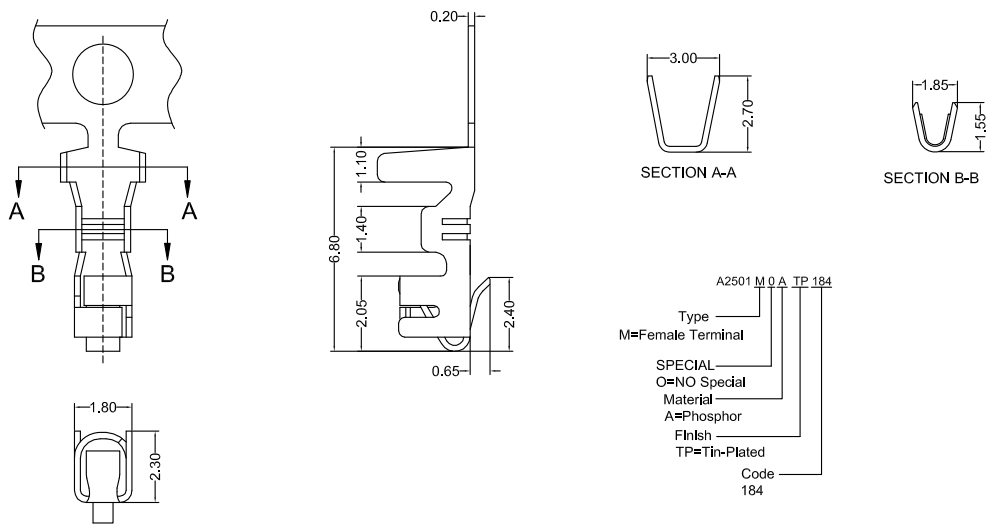

CSG PART NO.	Wire Range	Insulation O.D.	Q'ty/Reel
A2501M0ATP184	AWG#22-#28	1.80mm(max)	8000PCS



A2505 XHB

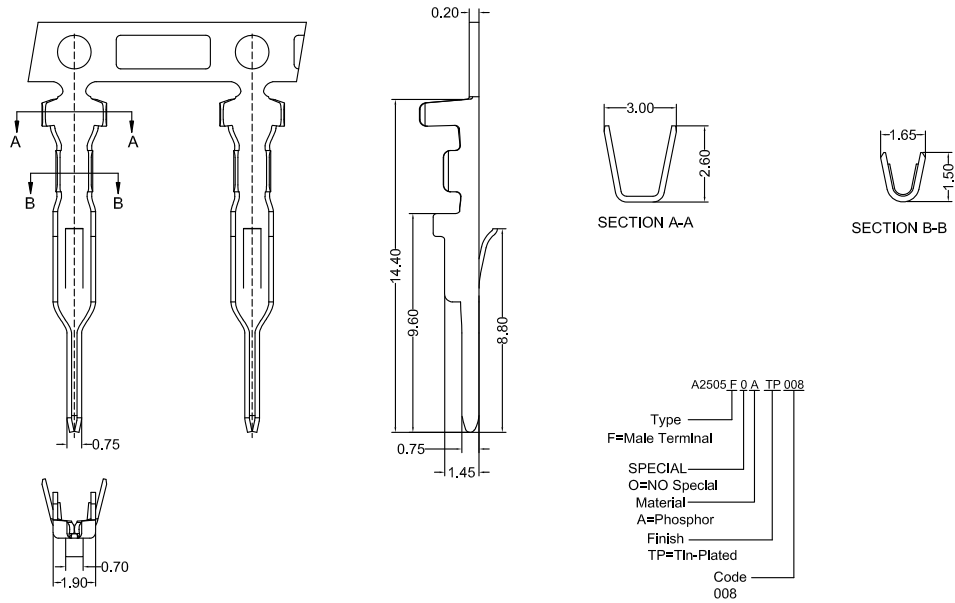

CSG PART NO.	Wire Range	Insulation O.D.	Q'ty/Reel
A2505F0ATP008	AWG#22-#28	1.90mm(max)	9000PCS

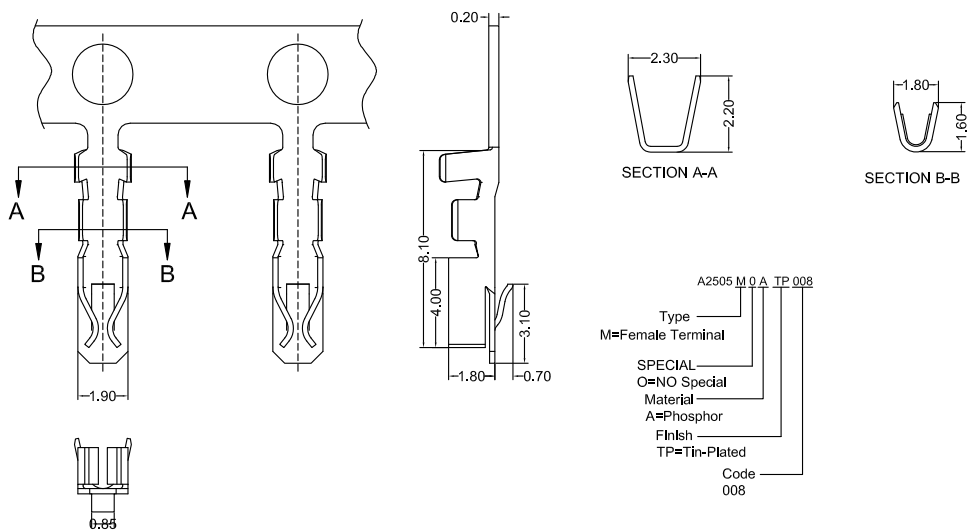

CSG PART NO.	Wire Range	Insulation O.D.	Q'ty/Reel
A2505M0ATP008	AWG#22-#28	1.90mm(max)	11000PCS



A2505 XHB

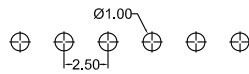
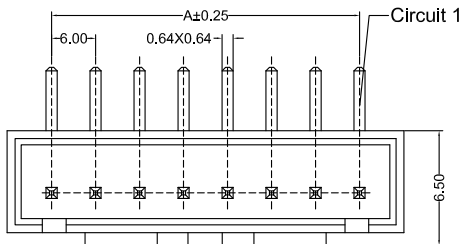
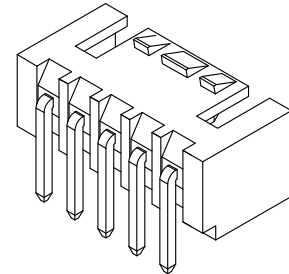
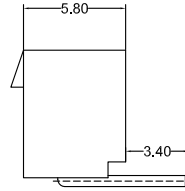
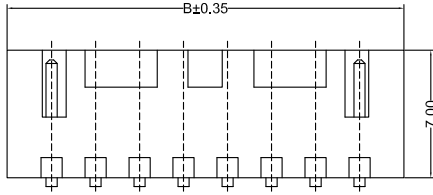

Recommended P.C.B Layout
General Tolerance±0.05

A2505RD_0XX AA P6 TP C 9 008
 PIN 002=2PINS
 SPECIAL
 AA=NO Special
 Material P6=PA66 94V-0
 Finish TP=Terminal Tin-Plated
 Code 008
 Color 9=White
 Packing C=Bag

CSG PART NO.	Dimension mm		Qty/BAG
	A	B	
A2505RD002AAP6TPC9008	2.50	7.50	1000PCS
A2505RD003AAP6TPC9008	5.00	10.00	1000PCS
A2505RD004AAP6TPC9008	7.50	12.50	1000PCS
A2505RD005AAP6TPC9008	10.00	15.00	1000PCS
A2505RD006AAP6TPC9008	12.50	17.50	1000PCS
A2505RD007AAP6TPC9008	15.00	20.00	1000PCS
A2505RD008AAP6TPC9008	17.50	22.50	1000PCS
A2505RD009AAP6TPC9008	20.00	25.00	1000PCS
A2505RD010AAP6TPC9008	22.50	27.50	1000PCS
A2505RD011AAP6TPC9008	25.00	30.00	1000PCS
A2505RD012AAP6TPC9008	27.50	32.50	1000PCS
A2505RD013AAP6TPC9008	30.00	35.00	1000PCS
A2505RD014AAP6TPC9008	32.50	37.50	1000PCS
A2505RD015AAP6TPC9008	35.00	40.00	1000PCS

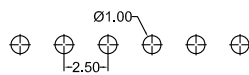
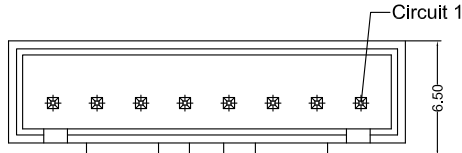
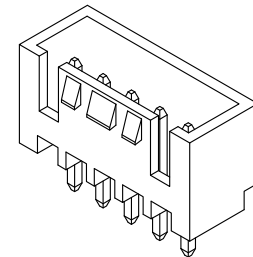
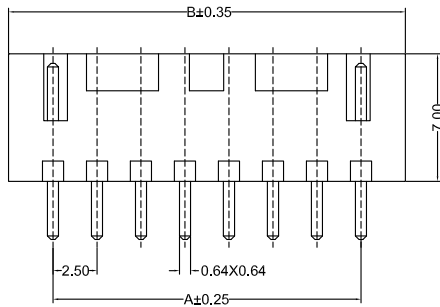

Recommended P.C.B Layout
General Tolerance±0.05

A2505VD_0XX AA P6 TP C X 007
 PIN 002=2PINS
 SPECIAL
 AA=NO Special
 Material P6=PA66 94V-0
 Finish TP=Terminal Tin-Plated
 Code 007
 Color 9=White
 Packing C=Belge
 C=Bag

CSG PART NO.	Dimension mm		Qty/BAG
	A	B	
A2505VD002AAP6TPCX007	2.50	7.50	1000PCS
A2505VD003AAP6TPCX007	5.00	10.00	1000PCS
A2505VD004AAP6TPCX007	7.50	12.50	1000PCS
A2505VD005AAP6TPCX007	10.00	15.00	1000PCS
A2505VD006AAP6TPCX007	12.50	17.50	1000PCS
A2505VD007AAP6TPCX007	15.00	20.00	1000PCS
A2505VD008AAP6TPCX007	17.50	22.50	1000PCS
A2505VD009AAP6TPCX007	20.00	25.00	1000PCS
A2505VD010AAP6TPCX007	22.50	27.50	1000PCS
A2505VD011AAP6TPCX007	25.00	30.00	1000PCS
A2505VD012AAP6TPCX007	27.50	32.50	1000PCS
A2505VD013AAP6TPCX007	30.00	35.00	1000PCS
A2505VD014AAP6TPCX007	32.50	37.50	1000PCS
A2505VD015AAP6TPCX007	35.00	40.00	1000PCS



A2505 XHB

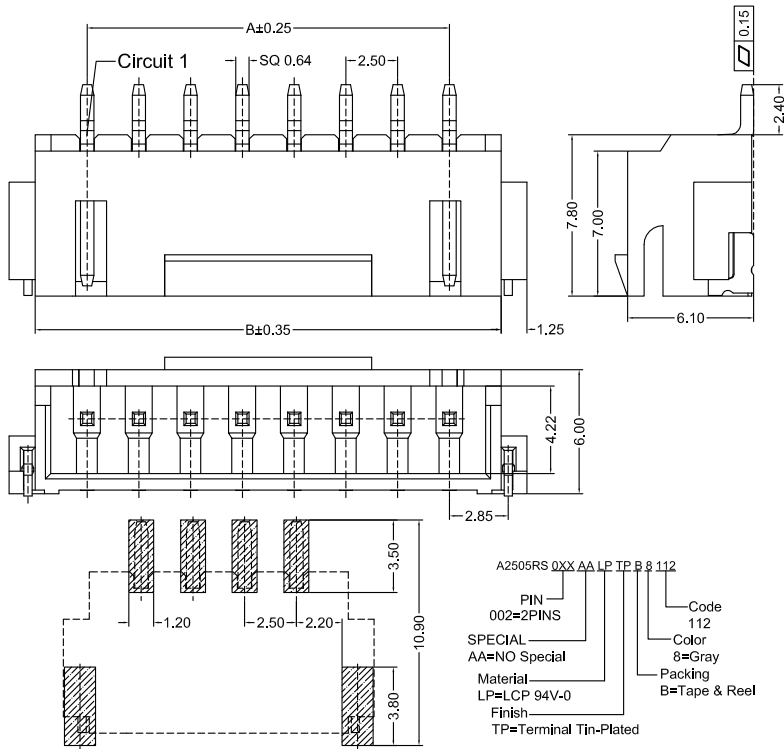

Recommended P.C.B Layout
General Tolerance±0.05

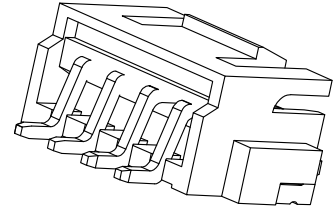

CSG PART NO.	Dimension mm		Q'ty/Reel
	A	B	
A2505RS002AALPTPB8112	2.50	7.50	500PCS
A2505RS003AALPTPB8112	5.00	10.00	500PCS
A2505RS004AALPTPB8112	7.50	12.50	500PCS
A2505RS005AALPTPB8112	10.00	15.00	500PCS
A2505RS006AALPTPB8112	12.50	17.50	500PCS
A2505RS007AALPTPB8112	15.00	20.00	500PCS
A2505RS008AALPTPB8112	17.50	22.50	500PCS
A2505RS009AALPTPB8112	20.00	25.00	500PCS
A2505RS010AALPTPB8112	22.50	27.50	500PCS
A2505RS011AALPTPB8112	25.00	30.00	500PCS
A2505RS012AALPTPB8112	27.50	32.50	500PCS
A2505RS013AALPTPB8112	30.00	35.00	500PCS
A2505RS014AALPTPB8112	32.50	37.50	500PCS
A2505RS015AALPTPB8112	35.00	40.00	500PCS
A2505RS016AALPTPB8112	37.50	42.50	500PCS

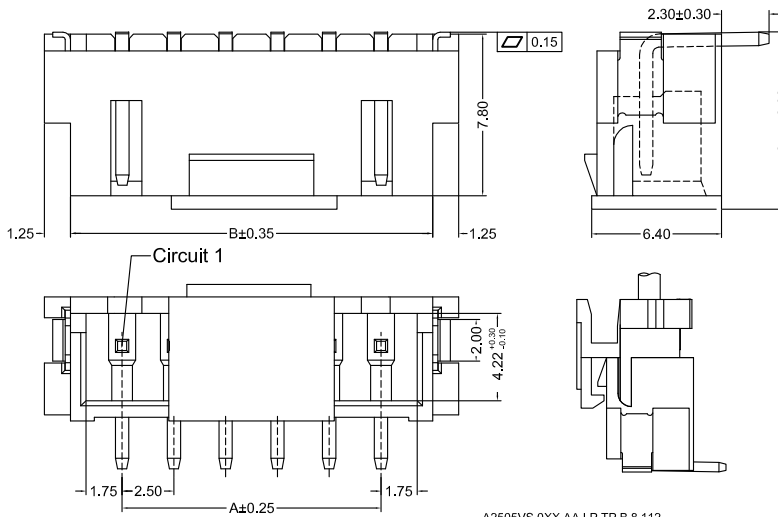

Recommended P.C.B Layout
General Tolerance±0.05

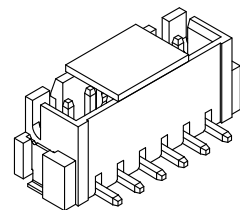

CSG PART NO.	Dimension mm		Q'ty/Reel
	A	B	
A2505VS002AALPTPB8112	2.50	7.50	500PCS
A2505VS003AALPTPB8112	5.00	10.00	500PCS
A2505VS004AALPTPB8112	7.50	12.50	500PCS
A2505VS005AALPTPB8112	10.00	15.00	500PCS
A2505VS006AALPTPB8112	12.50	17.50	500PCS
A2505VS007AALPTPB8112	15.00	20.00	500PCS
A2505VS008AALPTPB8112	17.50	22.50	500PCS
A2505VS009AALPTPB8112	20.00	25.00	500PCS
A2505VS010AALPTPB8112	22.50	27.50	500PCS
A2505VS011AALPTPB8112	25.00	30.00	500PCS
A2505VS012AALPTPB8112	27.50	32.50	500PCS
A2505VS013AALPTPB8112	30.00	35.00	500PCS
A2505VS014AALPTPB8112	32.50	37.50	500PCS
A2505VS015AALPTPB8112	35.00	40.00	500PCS
A2505VS016AALPTPB8112	37.50	42.50	500PCS

