

A1506 503149 CONNECTOR

1.50mm Pitch/Disconnectable Crimp style connectors

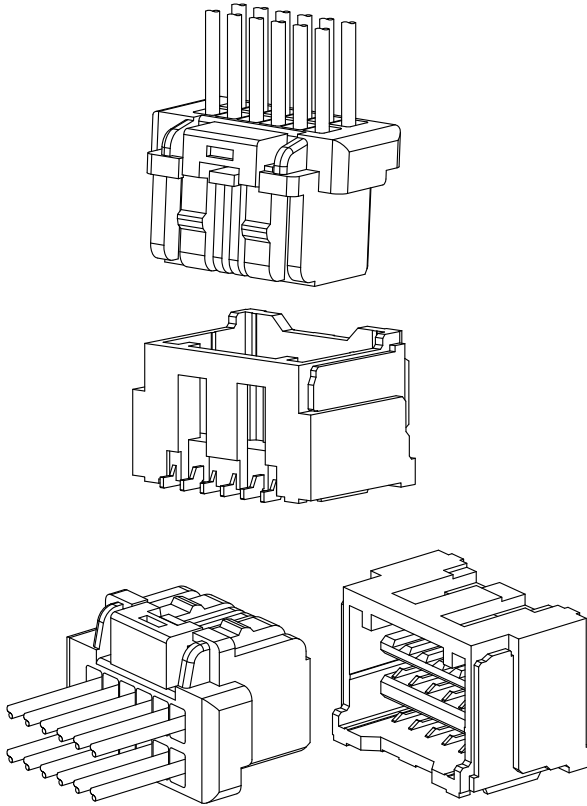

- Secure locking structure
- Low insertion force
- Suction area for picking up
- Improvement of engagement with prying

Specifications:

- Current rating: 2.0 A / AC,DC
- Voltage rating: 100 V AC/DC
- Temperature range: -25°C ~ +105°C
(including temperature rise in applying electrical current)
- Contact resistance: Initial value/ 20m Ω max
Insulation resistance: 500 M Ω min
Withstanding voltage: 500 VAC/minute
Applicable wire: Conductor size/ AWG#28~#24
Insulation O.D./ 0.60 to 1.10 mm

- * Compliant with RoHS2/ REACH
- * Refer to "General Instruction and Notice when using Terminals and Connectors"
- * Contact CSG for details

Material:

Housing: PBT/UL94-V0;Color:White/Black
Terminal: Phosphor/ Tin-plated/ Gold-Plated
Wafer Housing: PA9T,UL94-V0;Color:Natural
Wafer Pin: Phosphor/ Tin-plated, Gold-Plated
Wafer Fixed Foot: Bass/ Tin-plated

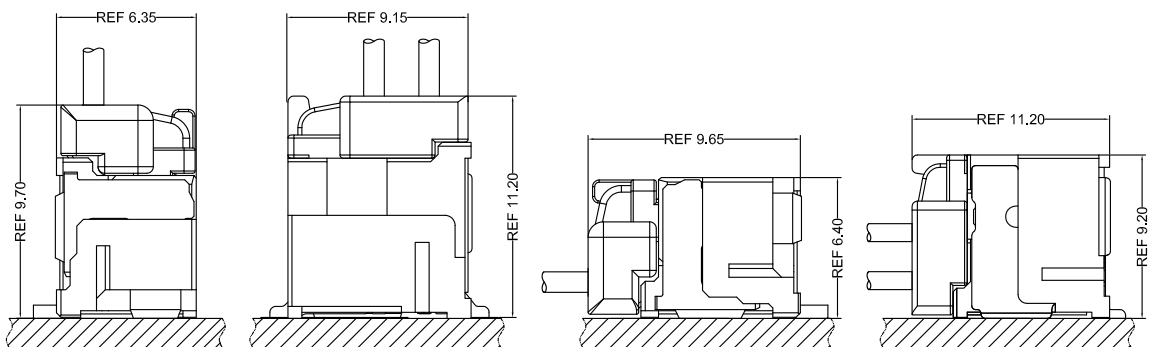

- Note: 1. The above figure is the figure viewed from the connector mounting side.
2. Tolerances are non-cumulative: ± 0.08 mm for all centers.
3. The dimensions above should serve as a guideline. Contact CSG for details.

CSG

A1506 503149

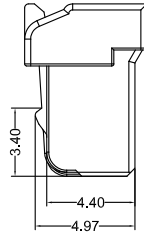
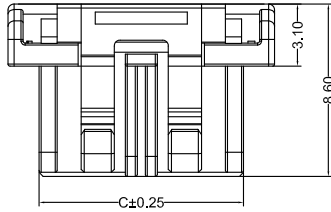
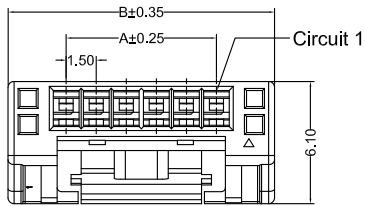

A1506HF 0XX AK PB X 001
 PIN
 005=5PINS
 SPECIAL
 AK=BUCKLE
 Material
 PB=PBT 94V-0
 Code
 001
 Color
 9=White
 0=Black

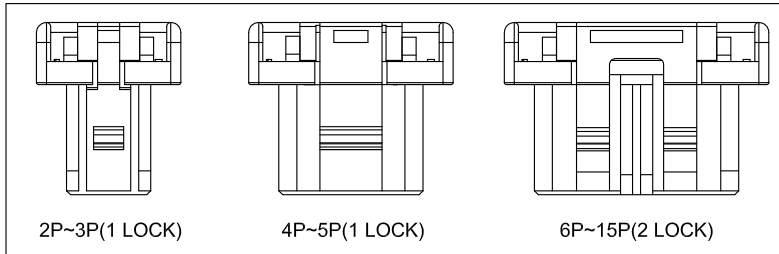
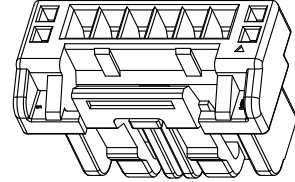

CSG PART NO.	Dimension mm			Q'ty/BAG
	A	B	C	
A1506HF002AKPBX001	1.50	7.30	4.20	1000PCS
A1506HF003AKPBX001	3.00	8.80	5.70	1000PCS
A1506HF004AKPBX001	4.50	10.30	7.20	1000PCS
A1506HF005AKPBX001	6.00	11.80	8.70	1000PCS
A1506HF006AKPBX001	7.50	13.30	10.20	1000PCS
A1506HF007AKPBX001	9.00	14.80	11.70	1000PCS
A1506HF008AKPBX001	10.50	16.30	13.20	1000PCS
A1506HF009AKPBX001	12.00	17.80	14.70	1000PCS
A1506HF010AKPBX001	13.50	19.30	16.20	1000PCS
A1506HF011AKPBX001	15.00	20.80	17.70	1000PCS
A1506HF012AKPBX001	16.50	22.30	19.20	1000PCS
A1506HF013AKPBX001	18.00	23.80	20.70	1000PCS
A1506HF014AKPBX001	19.50	25.30	22.20	1000PCS
A1506HF015AKPBX001	21.00	26.80	23.70	1000PCS

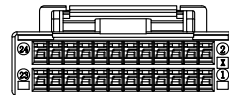
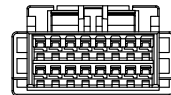
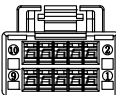
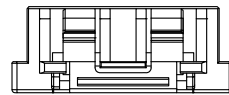
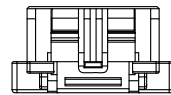
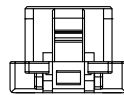
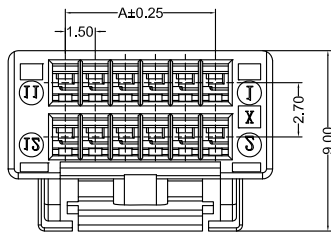

2X4P~2X5P

2X6P~2X9P

2X10P~2X20P

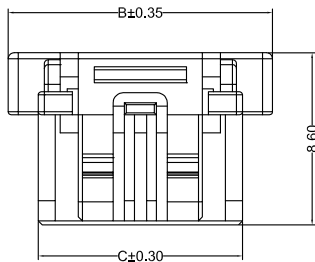

A1506HF 2XX AK PB X 001
 PIN
 205=2X5PINS
 SPECIAL
 AK=BUCKLE
 Material
 PB=PBT 94V-0
 Code
 001
 Color
 9=White
 0=Black

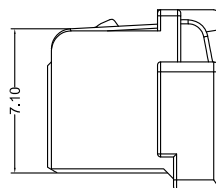
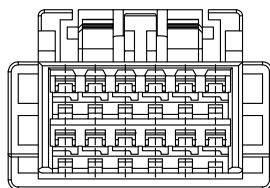
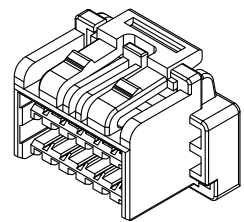

CSG PART NO.	Dimension mm			Q'ty/BAG
	A	B	C	
A1506HF204AKPBX001	4.50	10.20	7.20	1000PCS
A1506HF205AKPBX001	6.00	11.70	8.70	1000PCS
A1506HF206AKPBX001	7.50	13.20	10.20	1000PCS
A1506HF207AKPBX001	9.00	14.70	11.70	1000PCS
A1506HF208AKPBX001	10.50	16.20	13.20	1000PCS
A1506HF209AKPBX001	12.00	17.70	14.70	1000PCS
A1506HF210AKPBX001	13.50	19.20	16.20	1000PCS
A1506HF211AKPBX001	15.00	20.70	17.70	1000PCS
A1506HF212AKPBX001	16.50	22.20	19.20	1000PCS
A1506HF213AKPBX001	18.00	23.70	20.70	1000PCS
A1506HF214AKPBX001	19.50	25.20	22.20	1000PCS
A1506HF215AKPBX001	21.00	26.70	23.70	1000PCS
A1506HF216AKPBX001	22.50	28.20	25.20	1000PCS
A1506HF217AKPBX001	24.00	29.70	26.70	1000PCS
A1506HF218AKPBX001	25.50	31.20	28.20	1000PCS
A1506HF219AKPBX001	27.00	32.70	29.70	1000PCS
A1506HF220AKPBX001	28.50	34.20	31.20	1000PCS



A1506 503149

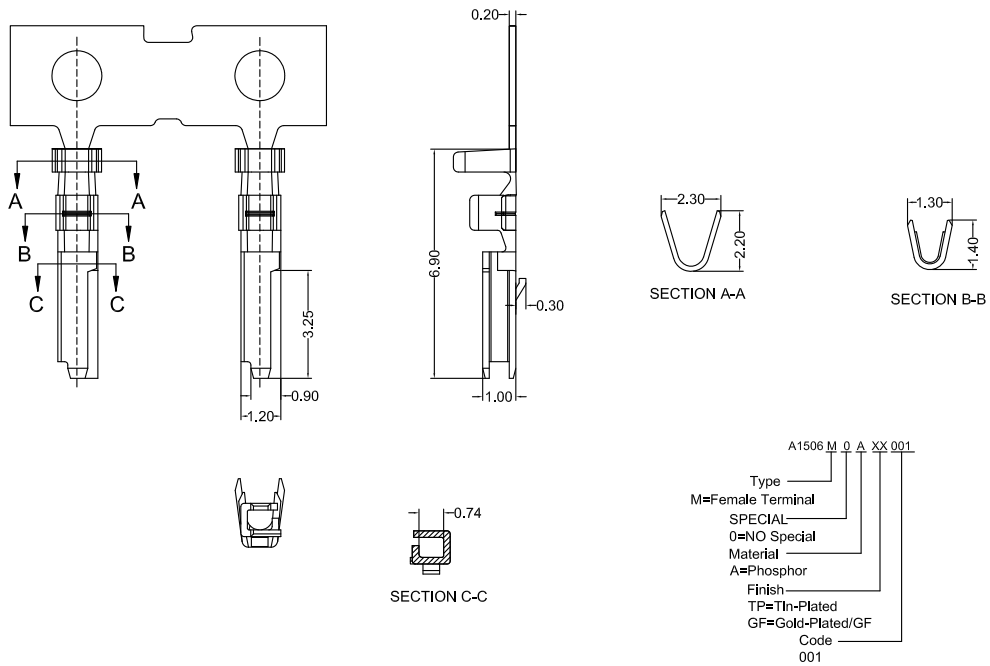

CSG PART NO.	Wire Range	Insulation O.D.	Q'ty/Reel
A1506M0ATP001	AWG#24-#28	1.28mm(max)	10000PCS
A1506M0AGF001	AWG#24-#28	1.28mm(max)	10000PCS

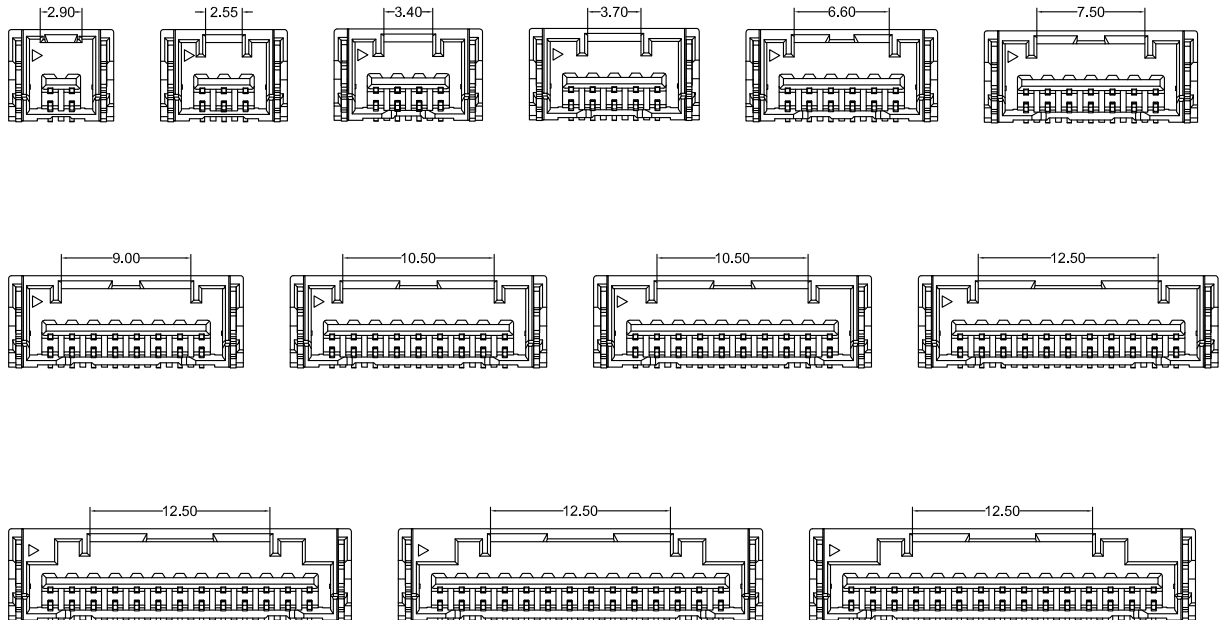

A1506 503149

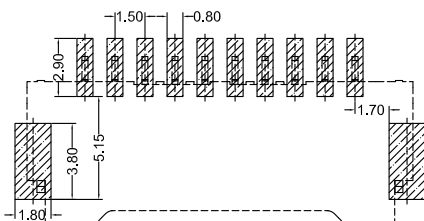
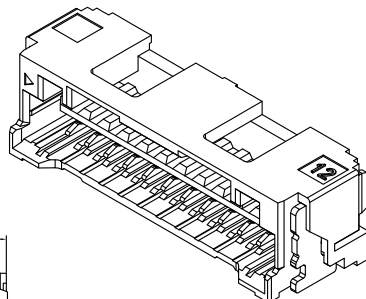
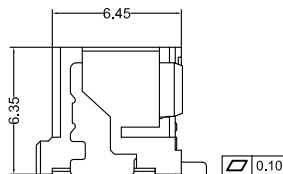
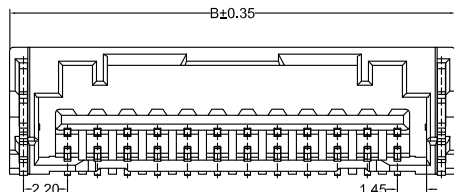
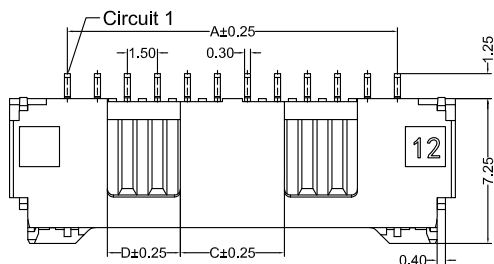

Recommended P.C.B Layout
General Tolerance±0.05

A1506RS 0XX AA 9T XX B A 001
 PIN
 004=4PINS
 SPECIAL
 AA=NO Special
 Material
 9T=PA9T 94V-0
 Finish
 TP=Terminal Tin-Plated
 GF=Terminal Gold-Plated
 Code
 001
 Color
 A=Natural
 Packing
 B=Tape & Reel

CSG PART NO.	Dimension mm				Q'ty/BAG
	A	B	C	D	
A1506RS002AA9TXXBA001	1.50	7.30	1.85	1000PCS	
A1506RS003AA9TXXBA001	3.00	8.80	2.55	1000PCS	
A1506RS004AA9TXXBA001	4.50	10.30	3.30	1000PCS	
A1506RS005AA9TXXBA001	6.00	11.80	3.60	1000PCS	
A1506RS006AA9TXXBA001	7.50	13.30	2.30	2.15	1000PCS
A1506RS007AA9TXXBA001	9.00	14.80	2.50	2.50	1000PCS
A1506RS008AA9TXXBA001	10.50	16.30	2.50	3.25	1000PCS
A1506RS009AA9TXXBA001	12.00	17.80	3.20	3.65	1000PCS
A1506RS010AA9TXXBA001	13.50	19.30	3.20	3.65	1000PCS
A1506RS011AA9TXXBA001	15.00	20.80	5.20	3.65	1000PCS
A1506RS012AA9TXXBA001	16.50	22.30	5.20	3.65	1000PCS
A1506RS013AA9TXXBA001	18.00	23.80	5.20	3.65	1000PCS
A1506RS014AA9TXXBA001	19.50	25.30	5.20	3.65	1000PCS
A1506RS015AA9TXXBA001	21.00	26.80	5.20	3.65	1000PCS

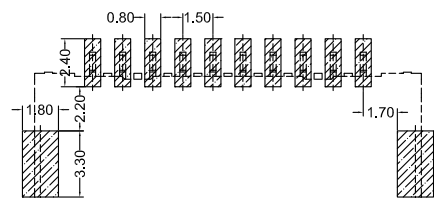
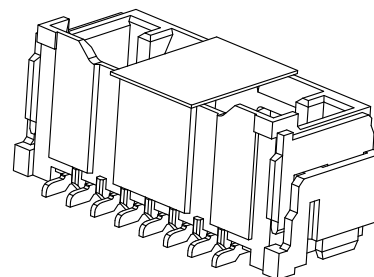
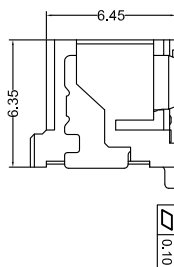
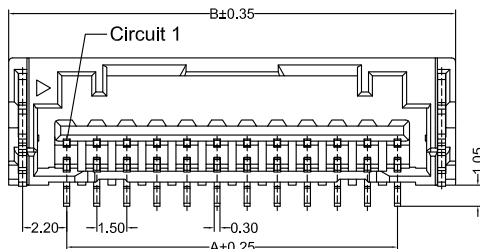
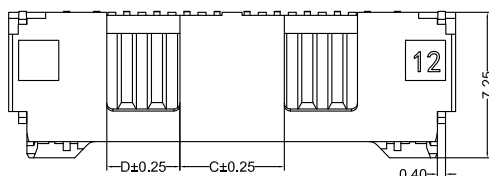

Recommended P.C.B Layout
General Tolerance±0.05

A1506VS 0XX AA 9T XX B A 001
 PIN
 004=4PINS
 SPECIAL
 AA=NO Special
 Material
 9T=PA9T 94V-0
 Finish
 TP=Terminal Tin-Plated
 GF=Terminal Gold-Plated
 Code
 001
 Color
 A=Natural
 Packing
 B=Tape & Reel

CSG PART NO.	Dimension mm				Q'ty/BAG
	A	B	C	D	
A1506VS002AA9TXXBA001	1.50	7.30	1.85	1000PCS	
A1506VS003AA9TXXBA001	3.00	8.80	2.55	1000PCS	
A1506VS004AA9TXXBA001	4.50	10.30	3.30	1000PCS	
A1506VS005AA9TXXBA001	6.00	11.80	3.60	1000PCS	
A1506VS006AA9TXXBA001	7.50	13.30	2.30	2.15	1000PCS
A1506VS007AA9TXXBA001	9.00	14.80	2.50	2.50	1000PCS
A1506VS008AA9TXXBA001	10.50	16.30	2.50	3.25	1000PCS
A1506VS009AA9TXXBA001	12.00	17.80	3.20	3.65	1000PCS
A1506VS010AA9TXXBA001	13.50	19.30	3.20	3.65	1000PCS
A1506VS011AA9TXXBA001	15.00	20.80	5.20	3.65	1000PCS
A1506VS012AA9TXXBA001	16.50	22.30	5.20	3.65	1000PCS
A1506VS013AA9TXXBA001	18.00	23.80	5.20	3.65	1000PCS
A1506VS014AA9TXXBA001	19.50	25.30	5.20	3.65	1000PCS
A1506VS015AA9TXXBA001	21.00	26.80	5.20	3.65	1000PCS



A1506 503149

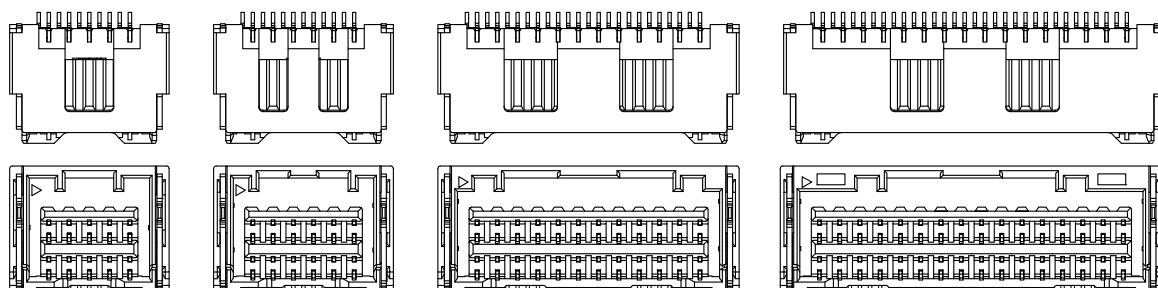

2X4P~2X5P

2X6P~2X9P

2X10P~2X15P

2X16P~2X20P

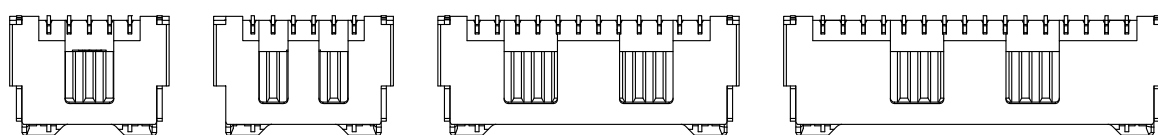

2X4P~2X5P

2X6P~2X9P

2X10P~2X15P

2X16P~2X20P

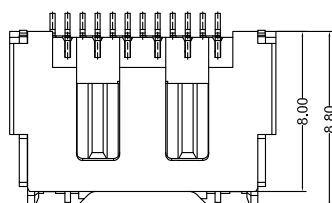

A1506RS 2XX AA 9T XX B A 001

PIN
204=2X4PINS
SPECIAL
AA=NO Special
Material
9T=PA9T 94V-0
Finish
TP=Terminal Tin-Plated
GF=Terminal Gold-Plated

Code
001
Color
A=Natural
Packing
B=Tape & Reel

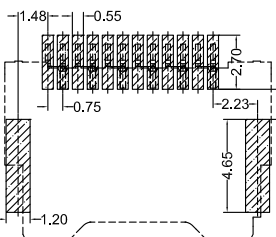
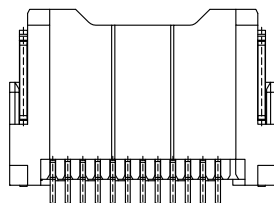
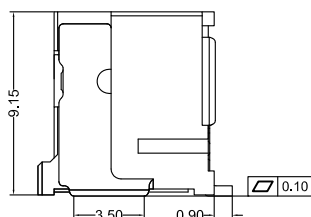
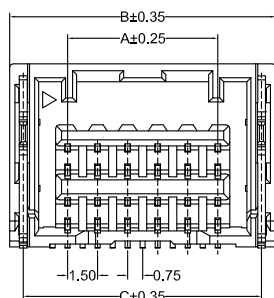
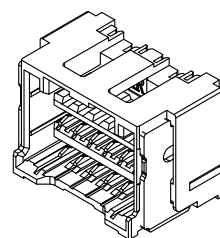

Recommended P.C.B Layout
General Tolerance±0.05

CSG PART NO.	Dimension mm			Q'ty/Reel
	A	B	C	
A1506RS204AA9TXXBA001	4.50	10.30	8.93	500PCS
A1506RS205AA9TXXBA001	6.00	11.80	10.43	500PCS
A1506RS206AA9TXXBA001	7.50	13.30	11.93	500PCS
A1506RS207AA9TXXBA001	9.00	14.80	13.43	500PCS
A1506RS208AA9TXXBA001	10.50	16.30	14.93	500PCS
A1506RS209AA9TXXBA001	12.00	17.80	16.43	500PCS
A1506RS210AA9TXXBA001	13.50	19.30	17.93	500PCS
A1506RS211AA9TXXBA001	15.00	20.80	19.43	500PCS
A1506RS212AA9TXXBA001	16.50	22.30	20.93	500PCS
A1506RS213AA9TXXBA001	18.00	23.80	22.43	500PCS
A1506RS214AA9TXXBA001	19.50	25.30	23.93	500PCS
A1506RS215AA9TXXBA001	21.00	26.80	25.43	500PCS
A1506RS216AA9TXXBA001	22.50	28.30	26.93	500PCS
A1506RS217AA9TXXBA001	24.00	29.80	28.43	500PCS
A1506RS218AA9TXXBA001	25.50	31.30	29.93	500PCS
A1506RS219AA9TXXBA001	27.00	32.80	31.43	500PCS
A1506RS220AA9TXXBA001	28.50	34.30	32.93	500PCS



A1506 503149

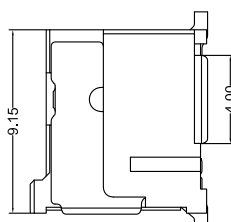
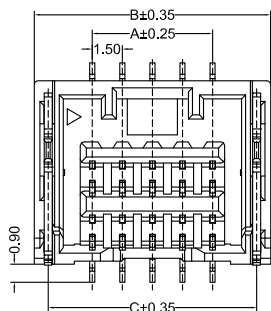
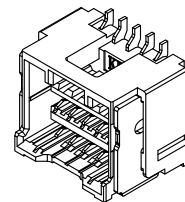
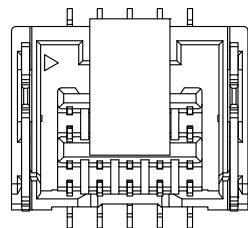
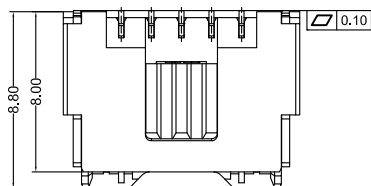

A1506VS 2XX AA 9T XX B A 001

- PIN
- 204=2X4PINS
- SPECIAL
- AA=NO Specal
- Material
- 9T=PA9T 94V-0
- Finish
- TP=Terminal Tin-Plated
- GF=Terminal Gold-Plated

- Code
- 001
- Color
- A=Natural
- Packing
- B=Tape & Reel

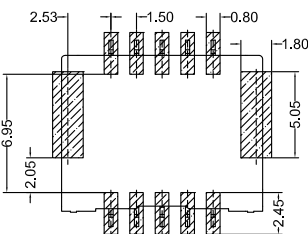
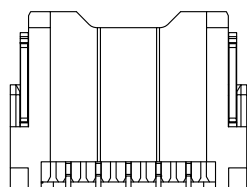

Recommended P.C.B Layout
General Tolerance±0.05

CSG PART NO.	Dimension mm			Q'ty/Reel
	A	B	C	
A1506VS204AA9TXXBA001	4.50	10.30	8.93	1000PCS
A1506VS205AA9TXXBA001	6.00	11.80	10.43	1000PCS
A1506VS206AA9TXXBA001	7.50	13.30	11.93	1000PCS
A1506VS207AA9TXXBA001	9.00	14.80	13.43	1000PCS
A1506VS208AA9TXXBA001	10.50	16.30	14.93	1000PCS
A1506VS209AA9TXXBA001	12.00	17.80	16.43	1000PCS
A1506VS210AA9TXXBA001	13.50	19.30	17.93	1000PCS
A1506VS211AA9TXXBA001	15.00	20.80	19.43	1000PCS
A1506VS212AA9TXXBA001	16.50	22.30	20.93	1000PCS
A1506VS213AA9TXXBA001	18.00	23.80	22.43	1000PCS
A1506VS214AA9TXXBA001	19.50	25.30	23.93	1000PCS
A1506VS215AA9TXXBA001	21.00	26.80	25.43	1000PCS
A1506VS216AA9TXXBA001	22.50	28.30	26.93	1000PCS
A1506VS217AA9TXXBA001	24.00	29.80	28.43	1000PCS
A1506VS218AA9TXXBA001	25.50	31.30	29.93	1000PCS
A1506VS219AA9TXXBA001	27.00	32.80	31.43	1000PCS
A1506VS220AA9TXXBA001	28.50	34.30	32.93	1000PCS