

# A2506 NH CONNECTOR

2.50mm Pitch/Disconnectable Crimp style connectors

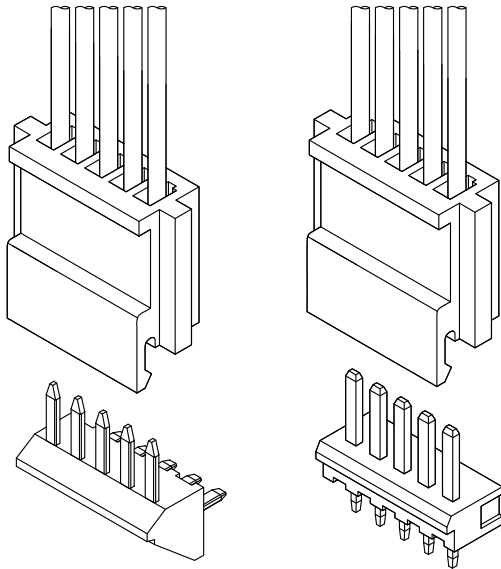

- Secure locking structure
- Low insertion force
- Suction area for picking up
- Improvement of engagement with prying

## Specifications:

- Current rating: 3.0 A / AC,DC (AWG #22)
- Voltage rating: 250 V AC/DC
- Temperature range: -40°C ~ +105°C  
(including temperature rise in applying electrical current)
- Contact resistance: Initial value/ 20m  $\Omega$  max  
Insulation resistance: 1000 M  $\Omega$  min  
Withstanding voltage: 1000 VAC/minute  
Applicable wire: Conductor size/ AWG#28~#22  
Insulation O.D./ 0.80 to 1.80 mm
- \* Compliant with RoHS2/ REACH
- \* Refer to "General Instruction and Notice when using Terminals and Connectors"
- \* Contact CSG for details

Material:

Housing: PA66/UL94-V0;Color:White

Terminal: Phosphor/ Tin-plated

DIP Wafer Housing: PA66,UL94-V0;Color:White

DIP Wafer Pin: Brass/ Tin-plated

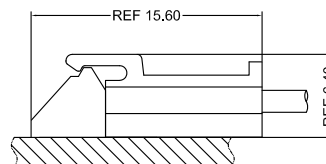
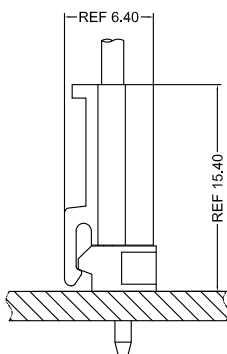

- Note: 1. The above figure is the figure viewed from the connector mounting side.  
2. Tolerances are non-cumulative:  $\pm 0.08$  mm for all centers.  
3. The dimensions above should serve as a guideline. Contact CSG for details.

**CSG**

# A2506 NH

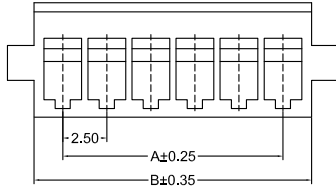

A2506HF 0XX AA P6 9 016  
 PIN  
 005=5PINS  
 SPECIAL  
 AA=NO Special  
 Material  
 P6=PA66 94V-0  
 Code  
 016  
 Color  
 9=White

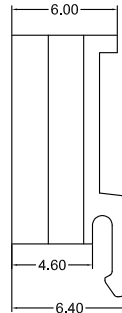
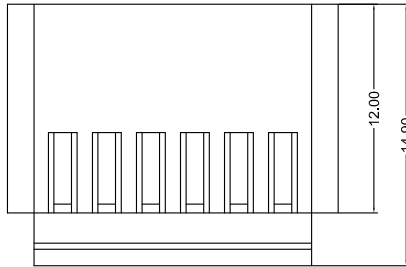
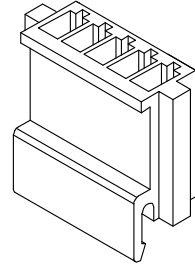

CSG PART NO.	Dimension mm		Q'ty/BAG
	A	B	
A2506HF002AAP69016	2.50	5.80	1000PCS
A2506HF003AAP69016	5.00	8.30	1000PCS
A2506HF004AAP69016	7.50	10.80	1000PCS
A2506HF005AAP69016	10.00	13.30	1000PCS
A2506HF006AAP69016	12.50	15.80	1000PCS
A2506HF007AAP69016	15.00	18.30	1000PCS
A2506HF008AAP69016	17.50	20.80	1000PCS
A2506HF009AAP69016	20.00	23.30	1000PCS
A2506HF010AAP69016	22.50	25.80	1000PCS
A2506HF011AAP69016	25.00	28.30	1000PCS
A2506HF012AAP69016	27.50	30.80	1000PCS
A2506HF013AAP69016	30.00	33.30	1000PCS
A2506HF014AAP69016	32.50	35.80	1000PCS
A2506HF015AAP69016	35.00	38.30	1000PCS
A2506HF016AAP69016	37.50	40.80	1000PCS
A2506HF017AAP69016	40.00	43.30	1000PCS
A2506HF018AAP69016	42.50	45.80	1000PCS
A2506HF019AAP69016	45.00	48.30	1000PCS
A2506HF025AAP69016	60.00	63.30	1000PCS

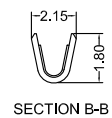
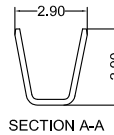
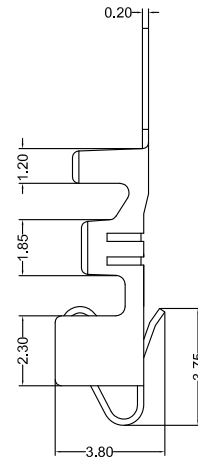
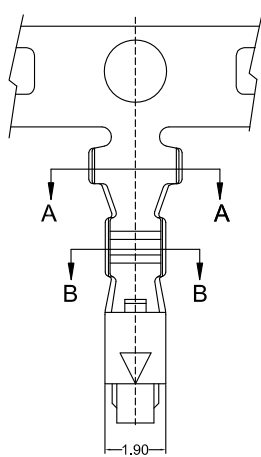

C2500 M 0 A TP 008  
 Type  
 M=Female Terminal  
 SPECIAL  
 O=NO Special  
 Material  
 A=Phosphor  
 Flsh  
 TP=Tin-Plated  
 Code  
 008

CSG PART NO.	Wire Range	Insulation O.D.	Q'ty/Reel
C2500M0ATP008	AWG#22-#26	1.80mm(max)	5000PCS



# A2506 NH

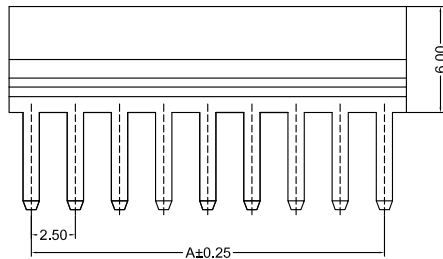

A2506RD.0XX AA P6 TP C 9 016

PIN  
002=2PINS

SPECIAL  
AA=NO Special

Material  
P6=PA66 94V-0

Finish  
TP=Terminal Tin-Plated

Code  
016

Color  
9=White

Packing  
C=Bag

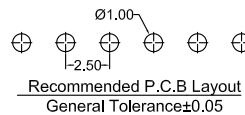
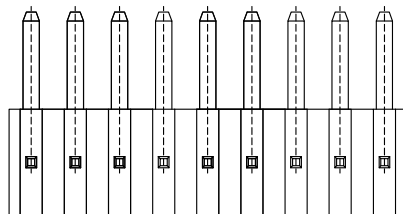
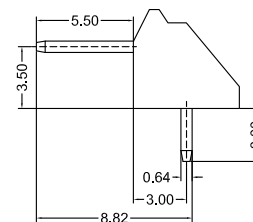
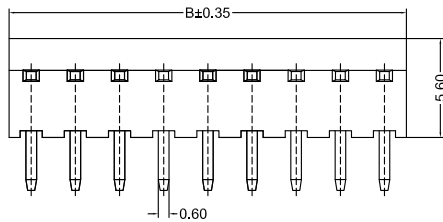
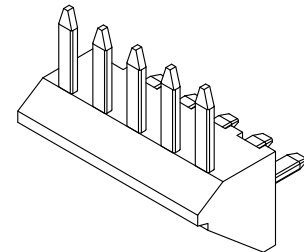

CSG PART NO.	Dimension mm		Q'ty/BAG
	A	B	
A2506RD002AAP6TPC9016	2.50	5.00	1000PCS
A2506RD003AAP6TPC9016	5.00	7.50	1000PCS
A2506RD004AAP6TPC9016	7.50	10.00	1000PCS
A2506RD005AAP6TPC9016	10.00	12.50	1000PCS
A2506RD006AAP6TPC9016	12.50	15.00	1000PCS
A2506RD007AAP6TPC9016	15.00	17.50	1000PCS
A2506RD008AAP6TPC9016	17.50	20.00	1000PCS
A2506RD009AAP6TPC9016	20.00	22.50	1000PCS
A2506RD010AAP6TPC9016	22.50	25.00	1000PCS

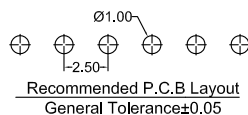
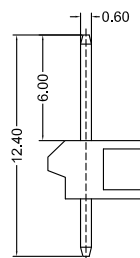
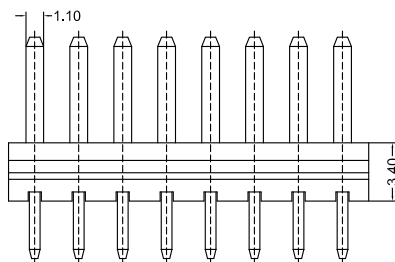
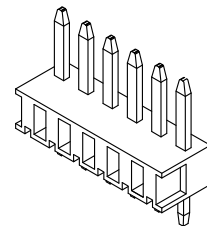

A2506VD.0XX AA P6 TP C 9 016

PIN  
002=2PINS

SPECIAL  
AA=NO Special

Material  
P6=PA66 94V-0

Finish  
TP=Terminal Tin-Plated

Code  
016

Color  
9=White

Packing  
C=Bag

CSG PART NO.	Dimension mm		Q'ty/BAG
	A	B	
A2506VD002AAP6TPC9016	2.50	5.00	1000PCS
A2506VD003AAP6TPC9016	5.00	7.50	1000PCS
A2506VD004AAP6TPC9016	7.50	10.00	1000PCS
A2506VD005AAP6TPC9016	10.00	12.50	1000PCS
A2506VD006AAP6TPC9016	12.50	15.00	1000PCS
A2506VD007AAP6TPC9016	15.00	17.50	1000PCS
A2506VD008AAP6TPC9016	17.50	20.00	1000PCS
A2506VD009AAP6TPC9016	20.00	22.50	1000PCS
A2506VD010AAP6TPC9016	22.50	25.00	1000PCS
A2506VD011AAP6TPC9016	25.00	27.50	1000PCS
A2506VD012AAP6TPC9016	27.50	30.00	1000PCS
A2506VD013AAP6TPC9016	30.00	32.50	1000PCS
A2506VD014AAP6TPC9016	32.50	35.00	1000PCS
A2506VD015AAP6TPC9016	35.00	37.50	1000PCS
A2506VD016AAP6TPC9016	37.50	40.00	1000PCS
A2506VD017AAP6TPC9016	40.00	42.50	1000PCS
A2506VD018AAP6TPC9016	42.50	45.00	1000PCS
A2506VD019AAP6TPC9016	45.00	47.50	1000PCS
A2506VD025AAP6TPC9016	60.00	62.50	1000PCS

