

C2500 SM CONNECTOR

2.50mm Pitch/Disconnectable Crimp style connectors

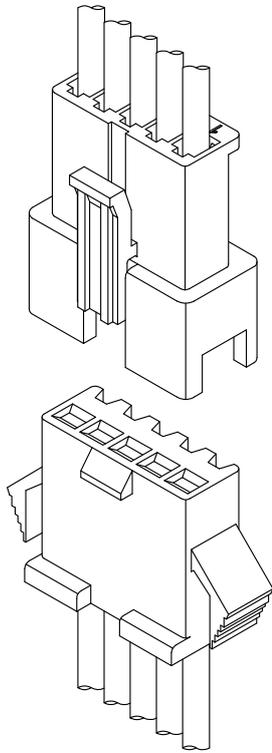

- Secure locking structure
- Low insertion force
- Suction area for picking up
- Improvement of engagement with prying

Specifications:

- Current rating: 3 A / AC,DC (AWG #22)
- Voltage rating: 250 V AC/DC
- Temperature range: -25°C ~ +105°C
(including temperature rise in applying electrical current)
- Contact resistance: Initial value/ 20m Ω max
Insulation resistance: 1500 MΩ min
Withstanding voltage: 500 VAC/minute
Applicable wire: Conductor size/ AWG#26~#22
Insulation O.D./ 1.1 to 1.80 mm
- * Compliant with RoHS2/ REACH
- * Refer to "General Instruction and Notice when using Terminals and Connectors"
- * Contact CSG for details

Material:

Housing: PA66/UL94-V0;Color:Black/White

Terminal: Phosphor or Brass/ Tin-plated

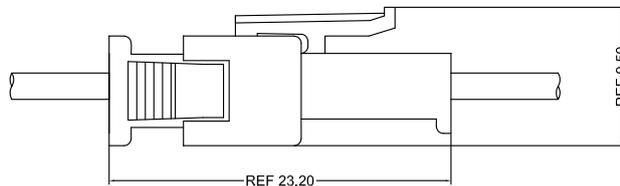

- Note: 1. The above figure is the figure viewed from the connector mounting side.
2. Tolerances are non-cumulative: ± 0.08 mm for all centers.
3. The dimensions above should serve as a guideline. Contact CSG for details.

CSG

C2500 SM

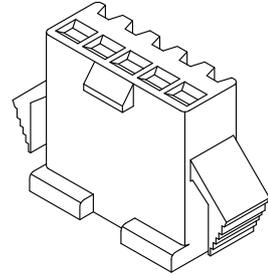
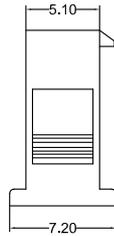
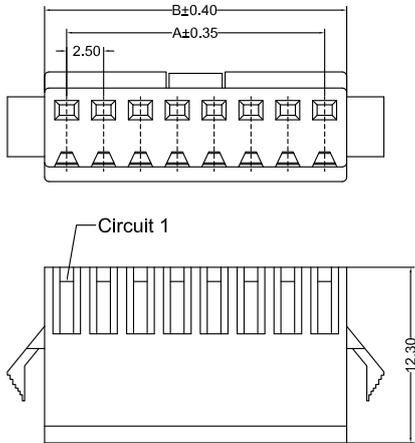

C2500HF 0XX AD P6 X 008
 PIN
 005=5PINS
 SPECIAL
 AD=Wings
 Material
 P6=PA66 94V-0
 Code
 008
 Color
 0=Black
 9=White

CSG PART NO.	Dimension mm		Q'ty/BAG
	A	B	
C2500HF002ADP6X008	2.50	5.50	1000PCS
C2500HF003ADP6X008	5.00	8.00	1000PCS
C2500HF004ADP6X008	7.50	10.50	1000PCS
C2500HF005ADP6X008	10.00	13.00	1000PCS
C2500HF006ADP6X008	12.50	15.50	1000PCS
C2500HF007ADP6X008	15.00	18.00	1000PCS
C2500HF008ADP6X008	17.50	20.50	1000PCS
C2500HF009ADP6X008	20.00	23.00	1000PCS
C2500HF010ADP6X008	22.50	25.50	1000PCS

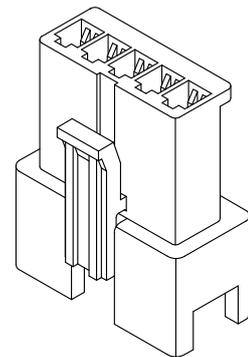
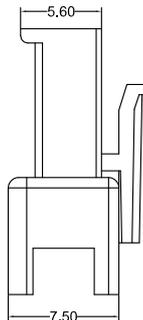
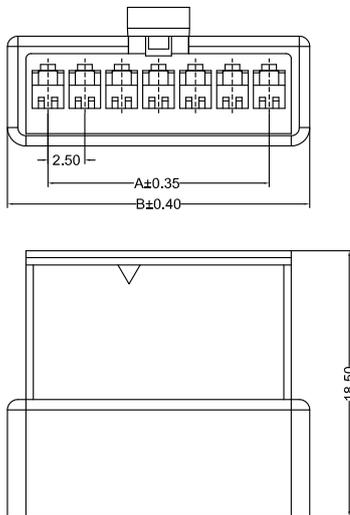

C2500HM 0XX AA P6 X 008
 PIN
 005=5PINS
 SPECIAL
 AA=NO Special
 Material
 P6=PA66 94V-0
 Code
 008
 Color
 0=Black
 9=White

CSG PART NO.	Dimension mm		Q'ty/BAG
	A	B	
C2500HM002AAP6X008	2.50	8.00	1000PCS
C2500HM003AAP6X008	5.00	10.50	1000PCS
C2500HM004AAP6X008	7.50	13.00	1000PCS
C2500HM005AAP6X008	10.00	15.50	1000PCS
C2500HM006AAP6X008	12.50	18.00	1000PCS
C2500HM007AAP6X008	15.00	20.50	1000PCS
C2500HM008AAP6X008	17.50	23.00	1000PCS
C2500HM009AAP6X008	20.00	25.50	1000PCS
C2500HM010AAP6X008	22.50	28.00	1000PCS



C2500 SM

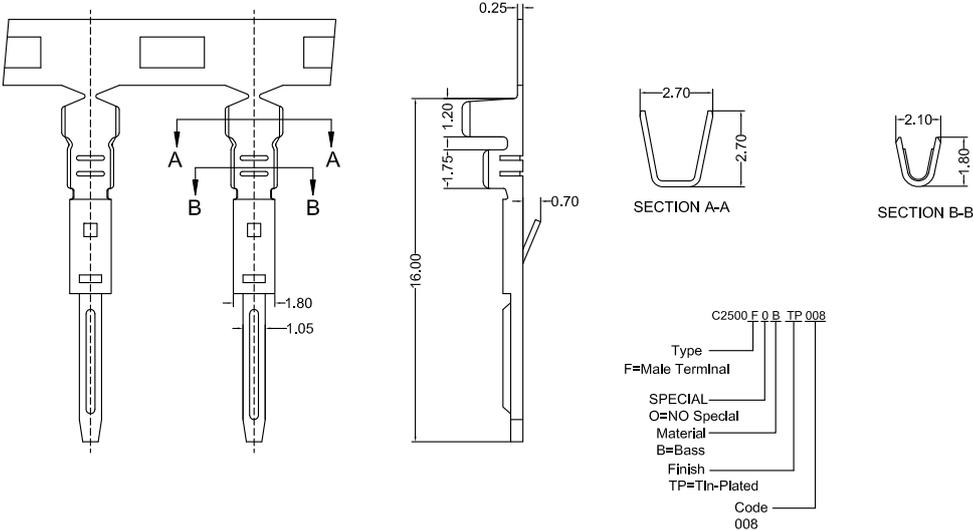

CSG PART NO.	Wire Range	Insulation O.D.	Qty/Reel
C2500F0BTP008	AWG#22-#26	1.80mm(max)	7000PCS

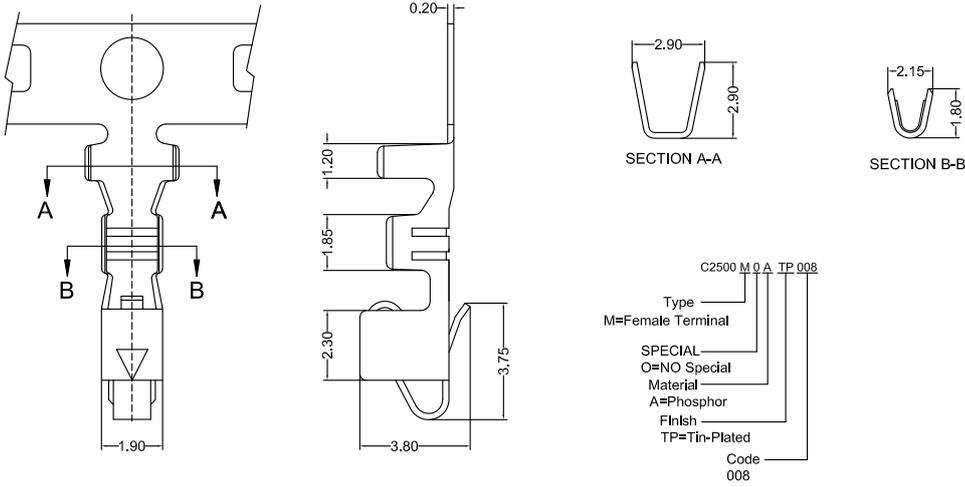

CSG PART NO.	Wire Range	Insulation O.D.	Qty/Reel
C2500M0ATP008	AWG#22-#26	1.80mm(max)	5000PCS

