

C4140 AMP 4.14 CONNECTOR

4.14mm Pitch/Disconnectable Crimp style connectors

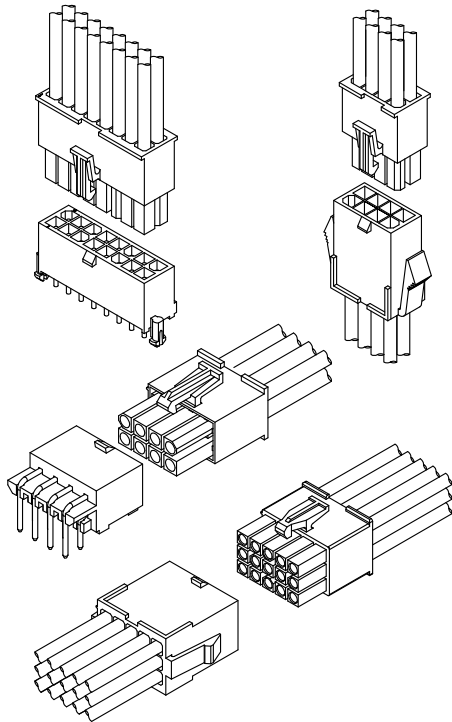

- Secure locking structure
- Low insertion force
- Suction area for picking up
- Improvement of engagement with prying

Specifications:

- Current rating: 7.0 A / AC,DC
- Voltage rating: 600 V AC/DC
- Temperature range: -25°C ~ +105°C
(including temperature rise in applying electrical current)
- Contact resistance: Initial value/ 20m Ω max
Insulation resistance: 1000 M Ω min
Withstanding voltage: 1500 VAC/minute
Applicable wire: Conductor size/ AWG#24~#22
Insulation O.D./ 1.30 to 1.75 mm

- * Compliant with RoHS2/ REACH
- * Refer to "General Instruction and Notice when using Terminals and Connectors"
- * Contact CSG for details

Material:

Housing: PA66/UL94-V2/0;Color:Translucent/White

Terminal: Brass/ Tin-plated

DIP Wafer Housing: PA66,UL94-V0;Color:White

DIP Wafer Pin: Brass/ Tin-plated

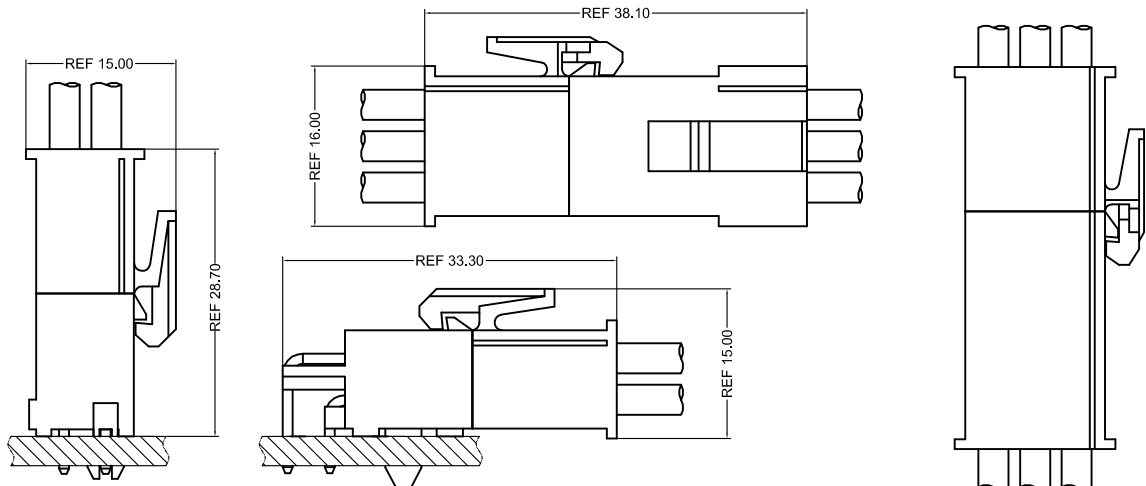

- Note: 1. The above figure is the figure viewed from the connector mounting side.
2. Tolerances are non-cumulative: ± 0.08 mm for all centers.
3. The dimensions above should serve as a guideline. Contact CSG for details.

CSG

Tel:+86-769-85312070 85375507 E-mail:James@csg-china.com www.csg-china.com

C4140 AMP 4.14

C4140VD002AP C4140VD003AP

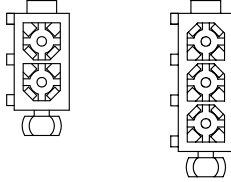

C4140VD202AP

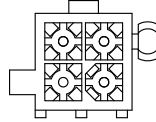

C4140VD203AP

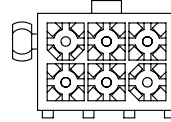

C4140VD204AP

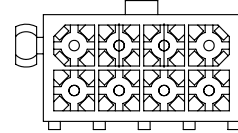

C4140VD205AP

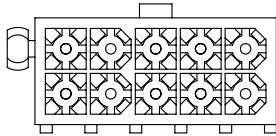

C4140VD206AP

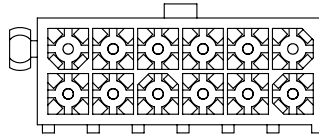

C4140VD303AP

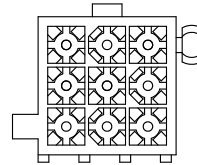

C4140VD304AP

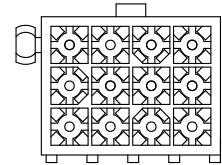

C4140VD305AP

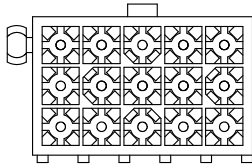

C4140RD002AP

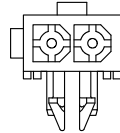

C4140RD003AP

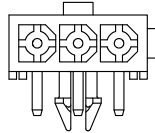

C4140RD202AP

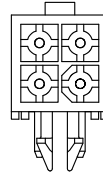

C4140RD203AP

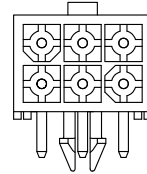

C4140RD204AP

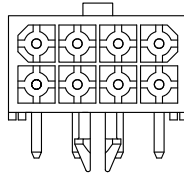

C4140RD205AP

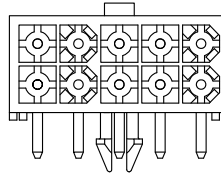

C4140RD206AP

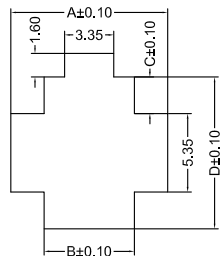
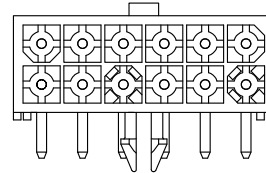

RECOMMENDED PANEL CUT-OUT
(DESIGNED FOR 0.80mm TO 2.00mm THICK
STAMPED PANEL OR PRINTED CIRCUIT BOARD)

CSG PART NO.	Dimension mm			
	A	B	C	D
C4140HM002ADP6X001	10.70	6.15	2.50	10.35
C4140HM003ADP6X001	10.70	6.15	4.60	14.55
C4140HM202ADP6X184	14.90	10.35	2.50	10.35
C4140HM203ADP6X184	19.10	14.55	2.50	10.35
C4140HM204ADP6X001	23.30	18.75	2.50	10.35
C4140HM205ADP6X001	27.50	22.95	2.50	10.35
C4140HM206ADP6X001	31.70	27.15	2.50	10.35
C4140HM207ADP6X001	35.90	31.35	2.50	10.35
C4140HM208ADP6X001	40.10	35.55	2.50	10.35
C4140HM209ADP6X001	44.30	39.75	2.50	10.35
C4140HM210ADP6X001	48.50	43.95	2.50	10.35
C4140HM211ADP6X001	52.70	48.15	2.50	10.35
C4140HM212ADP6X001	56.90	52.35	2.50	10.35
C4140HM303ADP6X001	19.10	14.55	4.60	14.55
C4140HM304ADP6X001	23.30	18.75	4.60	14.55
C4140HM305ADP6X001	27.50	22.95	4.60	14.55



C4140 AMP 4.14

2X4P

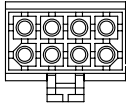

2X5P

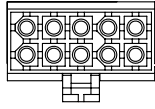

2X6P

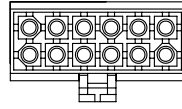

2X7P

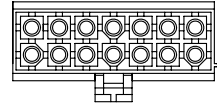

2X8P

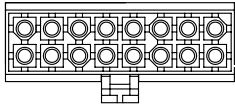

2X9P

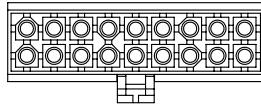

2X10P

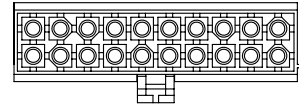

2X11P

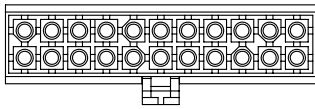

2X12P

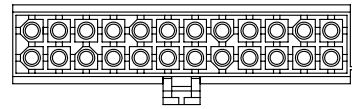

2X7P

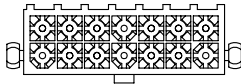

2X8P

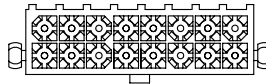

2X9P

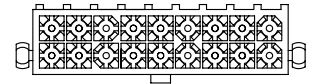

2X10P

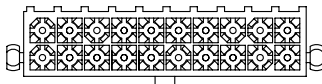

2X11P

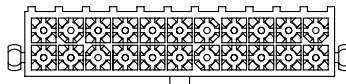

2X12P

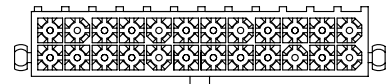

2X7P

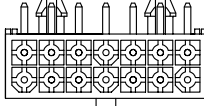

2X8P

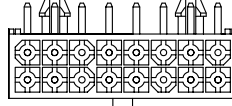

2X9P

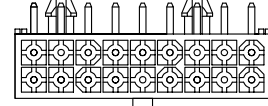

2X10P

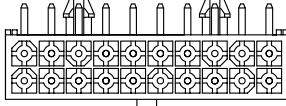

2X11P

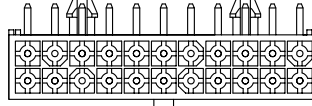

2X12P

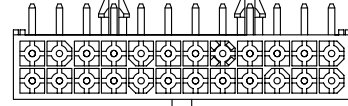

C4140 AMP 4.14

C4140HM001AAP6X184

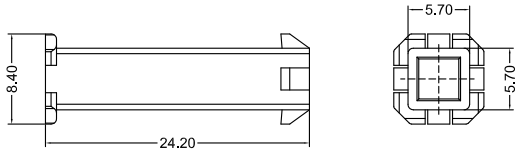

C4140HF001AKP6X184

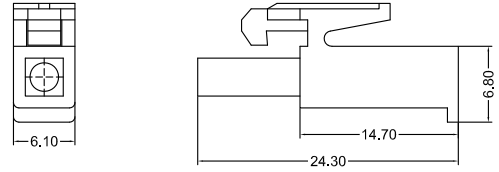

C4140HM002ADP6X001

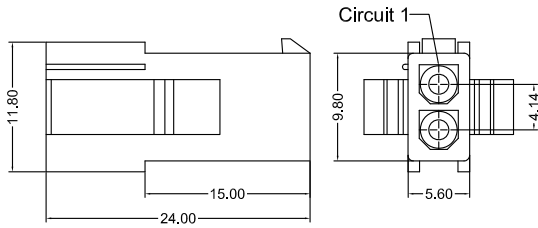

C4140HF002AKP6X184

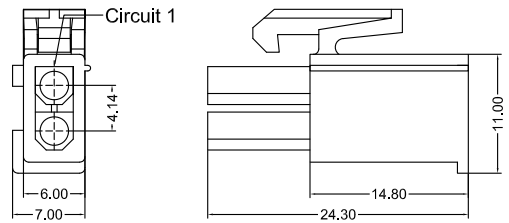

C4140HM002AAP6X184

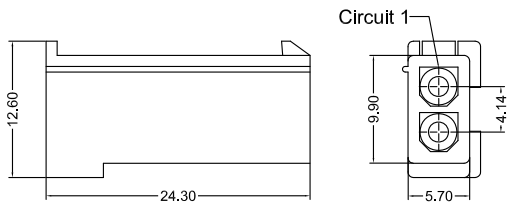

C4140HM003ADP6X001

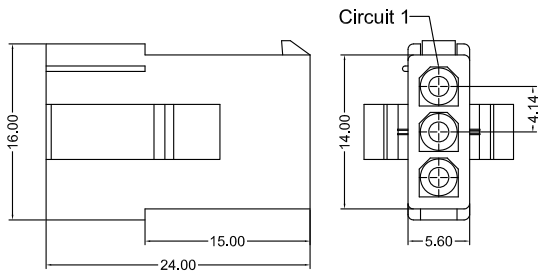

C4140HF003AKP6X184

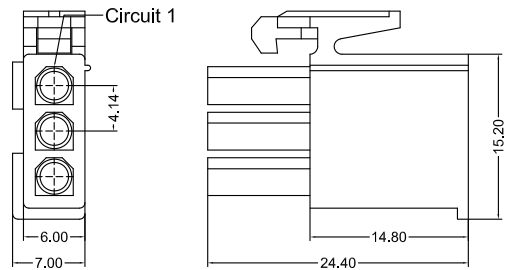

C4140HM003AAP6X184

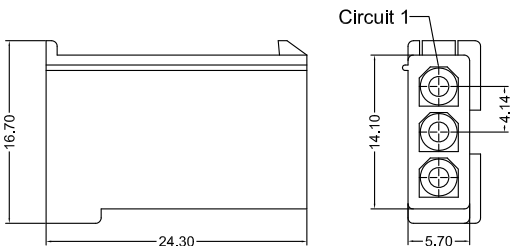

C4140 AMP 4.14

C4140HM202ADP6X184

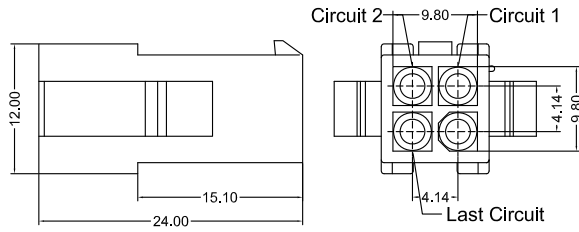

C4140HF202AKP6X184

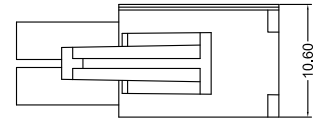

C4140HM202ADP6X184

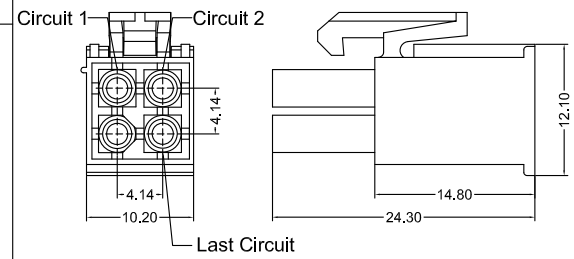
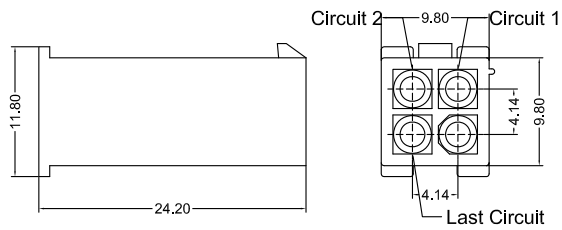

C4140HM203ADP6X184

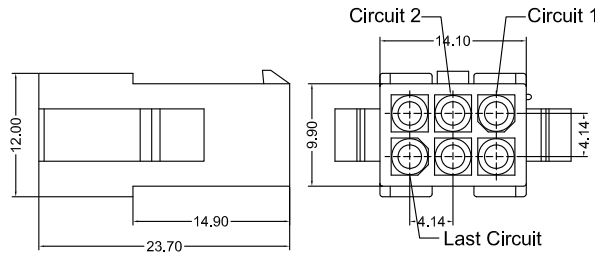

C4140HF203AKP6X184

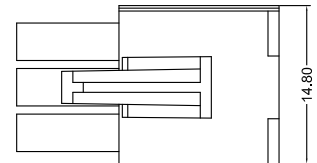

C4140HM203ADP6X184

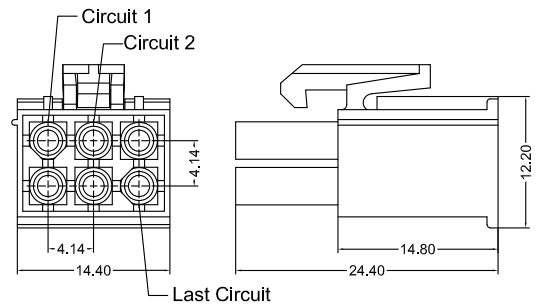
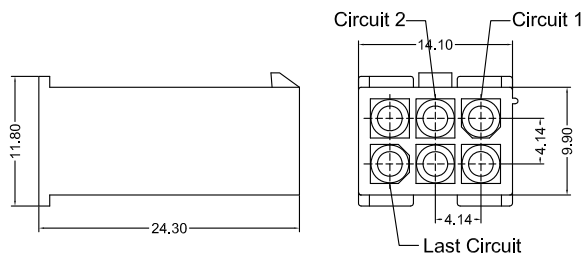

C4140 AMP 4.14

C4140HM303ADP6X001

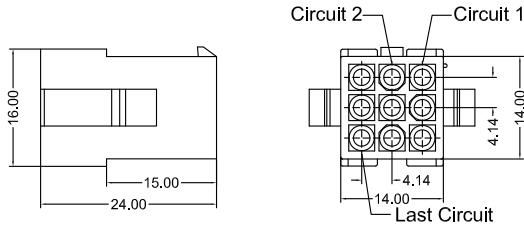

C4140HF303AKP6X184

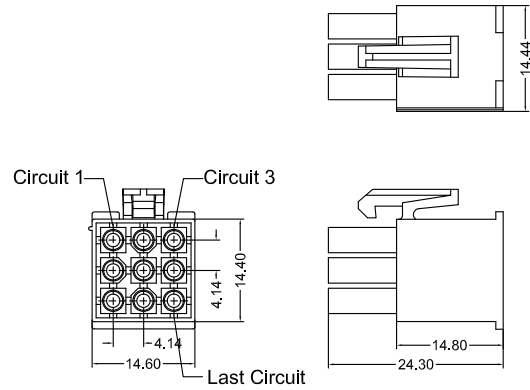

C4140HM303ADP6X184

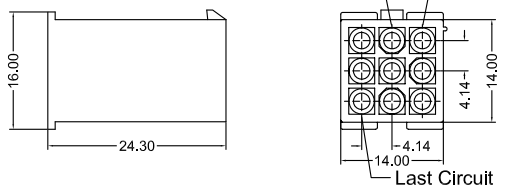

C4140HF304AKP6X184

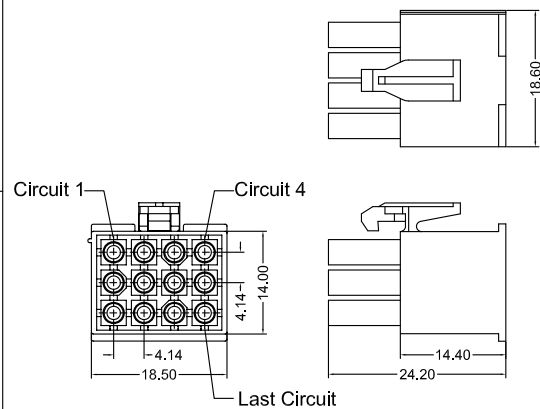

C4140HM304ADP6X001

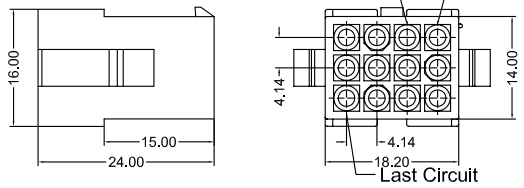

C4140HM304ADP6X184

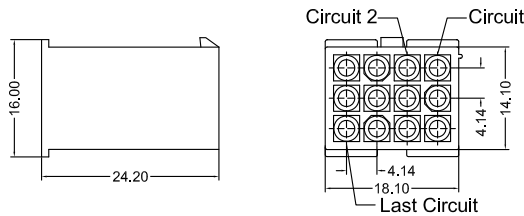

C4140HF305AKP6X184

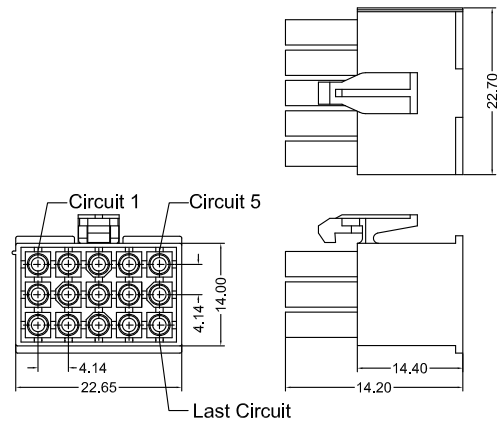

C4140HM305ADP6X001

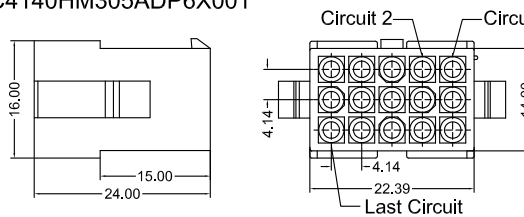

C4140HM305ADP6X184

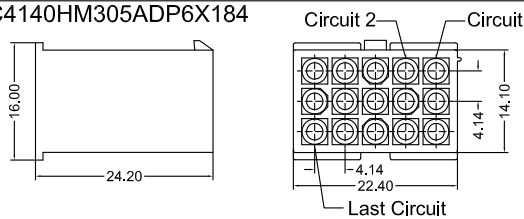

C4140 AMP 4.14

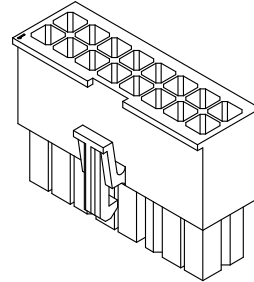
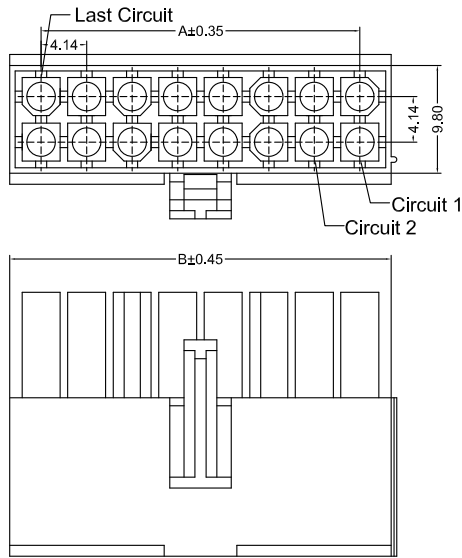

C4140HF 2XX AK P6 X XXX
 PIN 205=2X5PINS
 SPECIAL AK=BUCKLE
 Material P6=PA66 94-V0/V2
 Code 184 001
 Color 9=White B=Translucent

CSG PART NO.	Dimension mm		Q'ty/BAG
	A	B	
C4140HF204AKP6X001	12.42	18.47	1000PCS
C4140HF205AKP6X001	16.56	22.61	1000PCS
C4140HF206AKP6X001	20.70	26.75	1000PCS
C4140HF207AKP6X001	24.84	30.89	1000PCS
C4140HF208AKP6X001	28.98	35.03	1000PCS
C4140HF209AKP6X001	33.12	39.17	1000PCS
C4140HF210AKP6X001	37.26	43.31	1000PCS
C4140HF211AKP6X001	41.40	47.45	1000PCS
C4140HF212AKP6X001	45.54	51.59	1000PCS

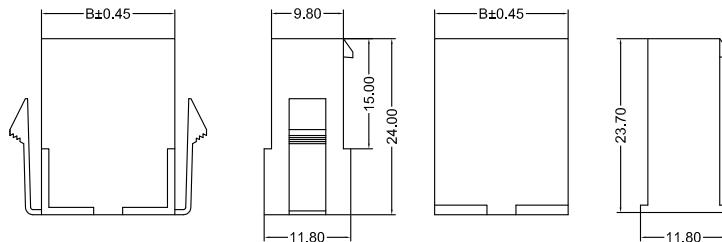
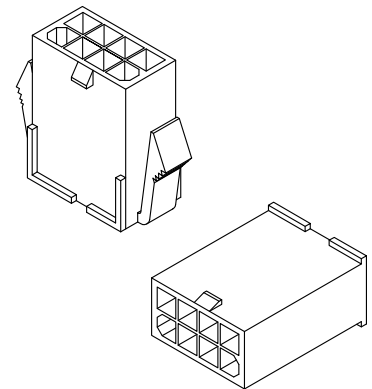
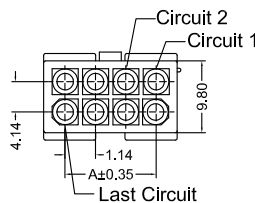
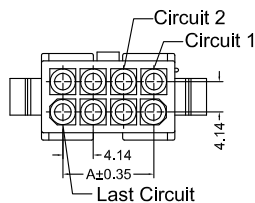

C4140HM 2XX XX P6 9 001
 PIN 205=2X5PINS
 SPECIAL AA=NO Spectral AD=Wings
 Material P6=PA66 94-V0
 Code 001
 Color 9=White

CSG PART NO.	Dimension mm		Q'ty/BAG
	A	B	
C4140HM204XXP69001	12.42	18.20	1000PCS
C4140HM205XXP69001	16.56	22.40	1000PCS
C4140HM206XXP69001	20.70	26.60	1000PCS
C4140HM207XXP69001	24.84	30.80	1000PCS
C4140HM208XXP69001	28.98	35.00	1000PCS
C4140HM209XXP69001	33.12	39.20	1000PCS
C4140HM210XXP69001	37.26	43.40	1000PCS
C4140HM211XXP69001	41.40	47.60	1000PCS
C4140HM212XXP69001	45.54	51.80	1000PCS



C4140 AMP 4.14

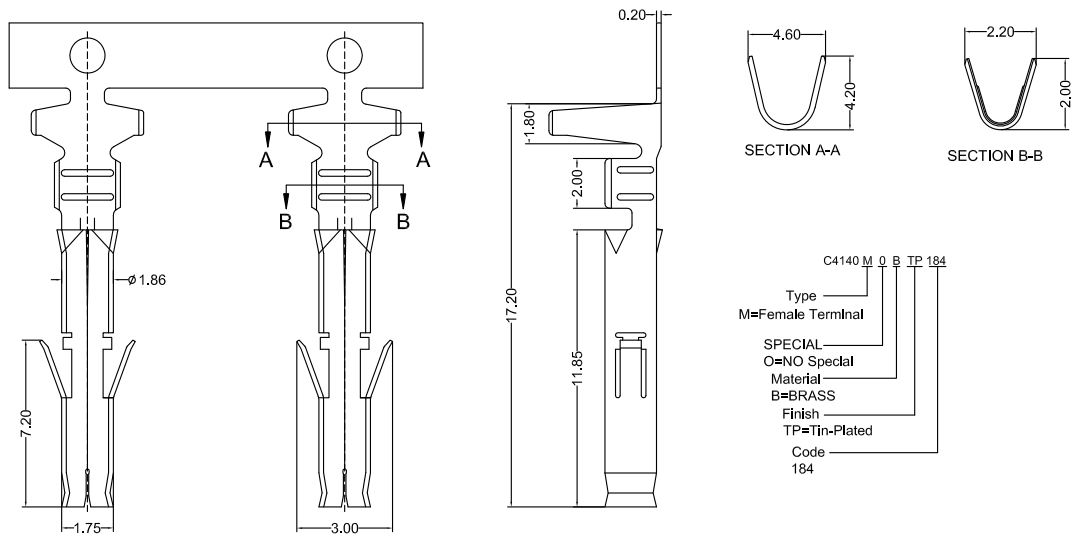

CSG PART NO.	Wire Range	Insulation O.D.	Q'ty/Reel
C4140M0BTP184	AWG#22-#24	1.75mm(max)	4000PCS

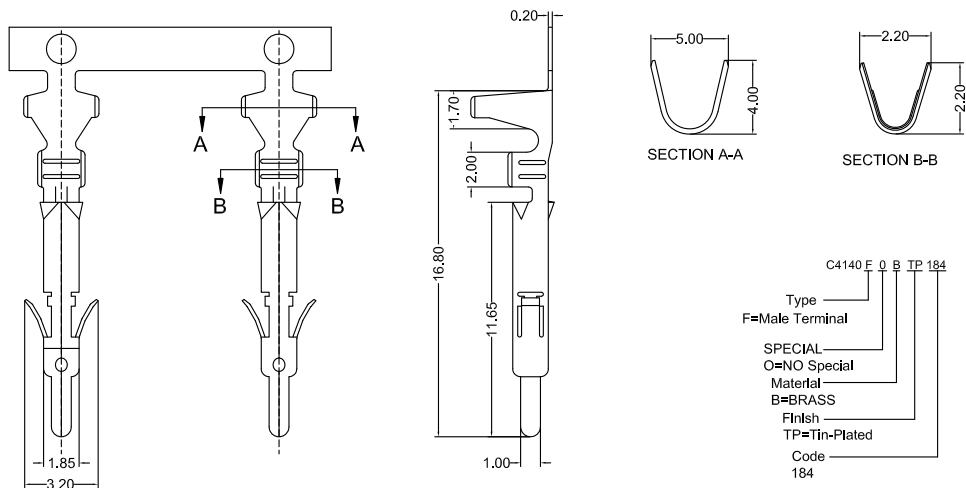

CSG PART NO.	Wire Range	Insulation O.D.	Q'ty/Reel
C4140F0BTP184	AWG#22-#24	1.75mm(max)	4000PCS



C4140 AMP 4.14

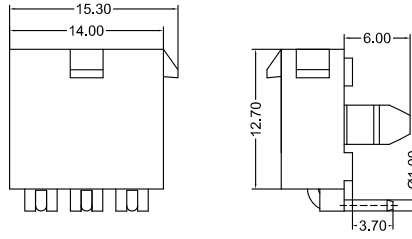
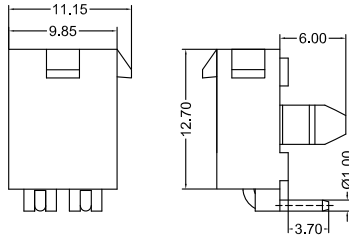
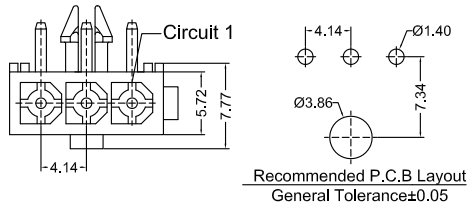
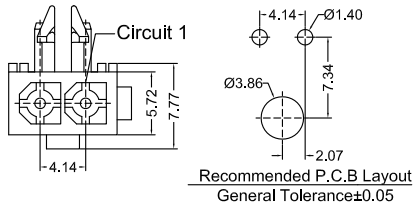

C4140RD 00X AP P6 TP C 9 001

PIN
003=3PINS
SPECIAL
AP=Pillars
Material
P6=PA66 94-V0
Finish
TP=Tin-Plated

Code
001
Color
9=White
Packing
C=Bag Packing

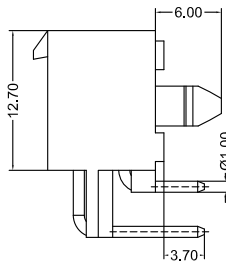
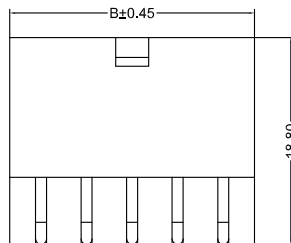
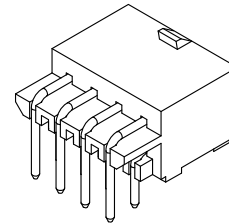
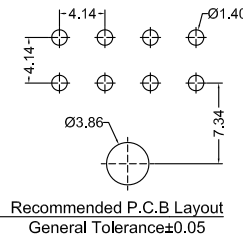
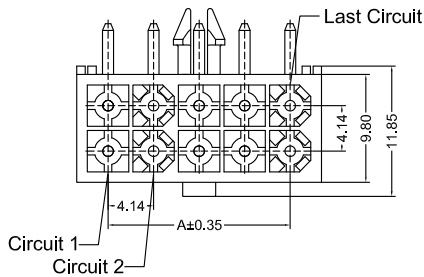

C4140RD 2XX AP P6 TP C 9 001

PIN
205=2X5PINS
SPECIAL
AP=Pillars
Material
P6=PA66 94-V0
Finish
TP=Tin-Plated

Code
001
Color
9=White
Packing
C=Bag Packing

CSG PART NO.	Dimension mm		Q'ty
	A	B	
C4140RD202APP6TPC9001	4.14	9.83	1000PCS
C4140RD203APP6TPC9001	8.28	13.97	1000PCS
C4140RD204APP6TPC9001	12.42	18.11	1000PCS
C4140RD205APP6TPC9001	16.56	22.25	1000PCS
C4140RD206APP6TPC9001	21.70	26.39	1000PCS



C4140 AMP 4.14

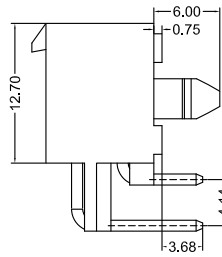
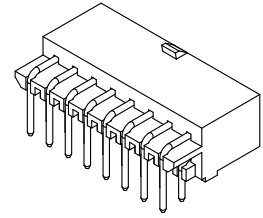
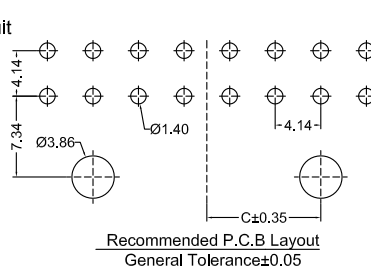
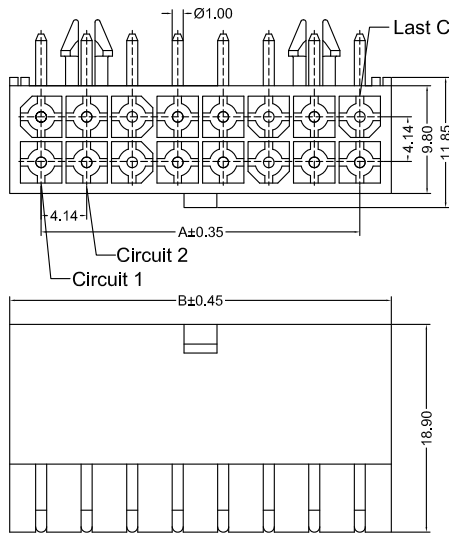

C4140RD 2XX AP P6 TP C 9 001

PIN
207=2X7PINS
SPECIAL
AP=Pinllars
Material
P6=PA66 94-V0
Finish
TP=Tin-Plated

Code
001
Color
9=White
Packing
C=Bag Packing

CSG PART NO.	Dimension mm			Q'ty
	A	B	C	
C4140RD207APP6TPC9001	24.84	30.56	8.28	1000PCS
C4140RD208APP6TPC9001	28.98	34.70	10.35	1000PCS
C4140RD209APP6TPC9001	33.12	38.84	10.35	1000PCS
C4140RD210APP6TPC9001	37.26	42.98	10.35	1000PCS
C4140RD211APP6TPC9001	41.40	47.12	10.35	1000PCS
C4140RD212APP6TPC9001	45.54	51.26	10.35	1000PCS

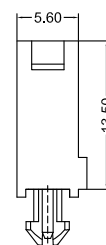
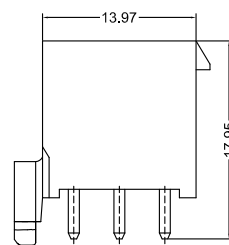
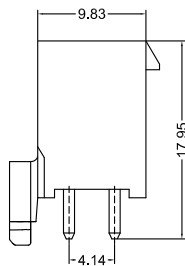
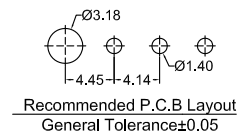
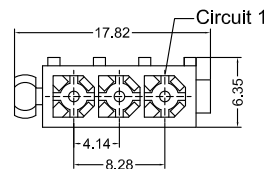
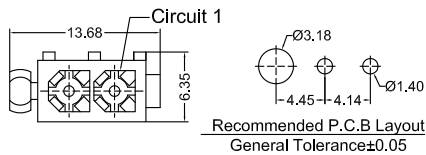

C4140VD 00X AP P6 TP C 9 001

PIN
003=3PINS
SPECIAL
AP=Pinllars
Material
P6=PA66 94-V0
Finish
TP=Tin-Plated

Code
001
Color
9=White
Packing
C=Bag Packing



C4140 AMP 4.14

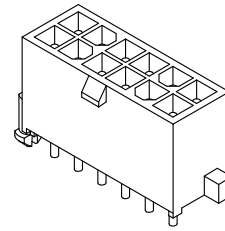
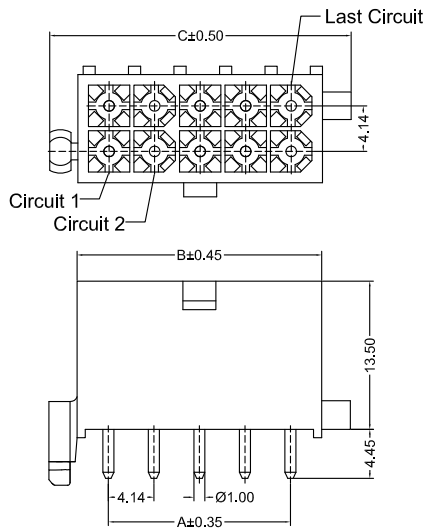

C4140VD 2XX AP P6 TP C 9 001
 PIN
 205=2X5PINS
 SPECIAL
 AP= Pillars
 Material
 P6=PA66 94-V0
 Finish
 TP=Tin-Plated
 Code
 001
 Color
 9=White
 Packing
 C=Bag Packing

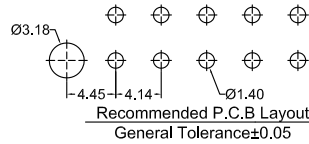

CSG PART NO.	Dimension mm			Q'ty
	A	B	C	
C4140VD202APP6TPC9001	4.14	9.83	15.01	1000PCS
C4140VD203APP6TPC9001	8.28	13.97	19.15	1000PCS
C4140VD204APP6TPC9001	12.42	18.11	23.27	1000PCS
C4140VD205APP6TPC9001	16.56	22.25	27.41	1000PCS
C4140VD206APP6TPC9001	21.70	26.39	31.55	1000PCS

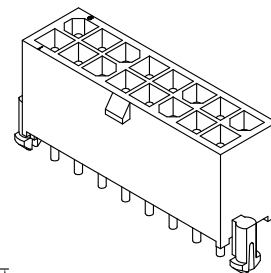
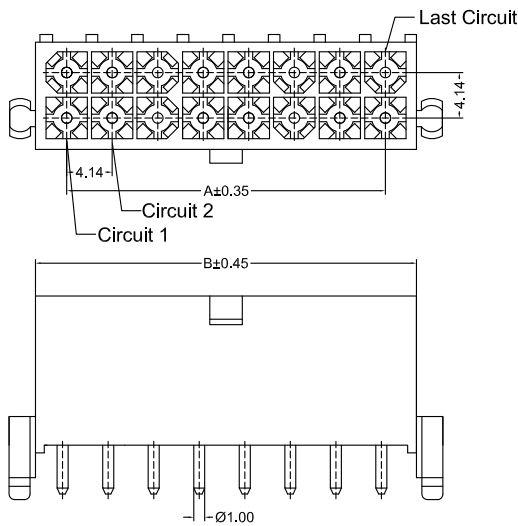

C4140VD 2XX AP P6 TP C 9 001
 PIN
 207=2X7PINS
 SPECIAL
 AP= Pillars
 Material
 P6=PA66 94-V0
 Finish
 TP=Tin-Plated
 Code
 001
 Color
 9=White
 Packing
 C=Bag Packing

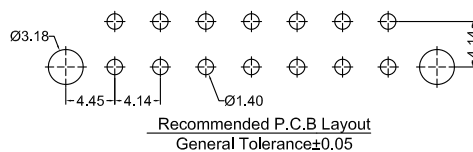

CSG PART NO.	Dimension mm			Q'ty
	A	B	C	
C4140VD207APP6TPC9001	24.84	30.56	8.28	1000PCS
C4140VD208APP6TPC9001	28.98	34.70	10.35	1000PCS
C4140VD209APP6TPC9001	33.12	38.84	10.35	1000PCS
C4140VD210APP6TPC9001	37.26	42.98	10.35	1000PCS
C4140VD211APP6TPC9001	41.40	47.12	10.35	1000PCS
C4140VD212APP6TPC9001	45.54	51.26	10.35	1000PCS



C4140 AMP 4.14

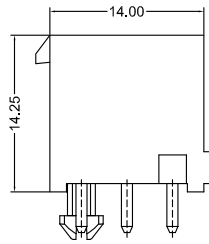
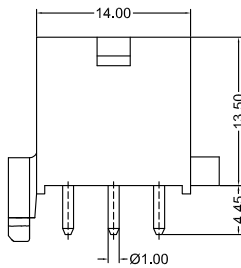
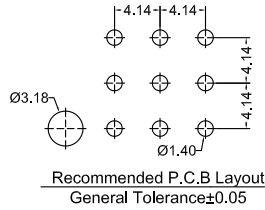
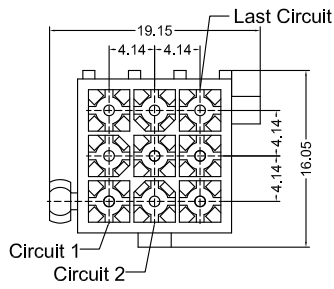

C4140VD 303 AP P6 TP C 9 001
 PIN
 303=3X3PINS
 SPECIAL
 AP=Pillars
 Material
 P6=PA66 94-V0
 Finish
 TP=Tin-Plated
 Code
 001
 Color
 9=White
 Packing
 C=Bag Packing

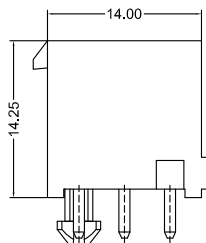
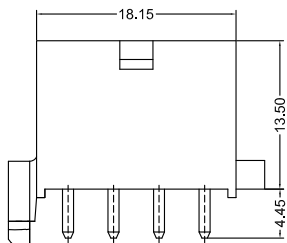
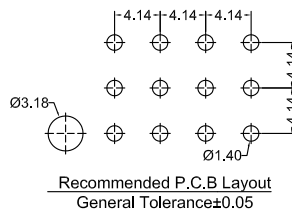
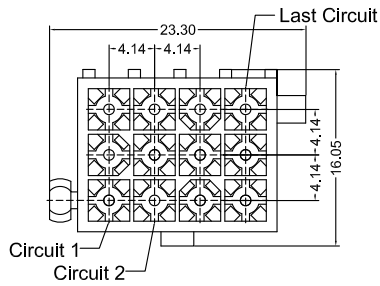

C4140VD 304 AP P6 TP C 9 001
 PIN
 304=3X4PINS
 SPECIAL
 AP=Pillars
 Material
 P6=PA66 94-V0
 Finish
 TP=Tin-Plated
 Code
 001
 Color
 9=White
 Packing
 C=Bag Packing



C4140 AMP 4.14

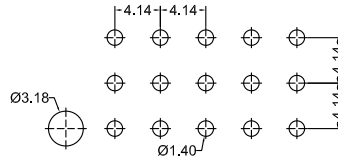
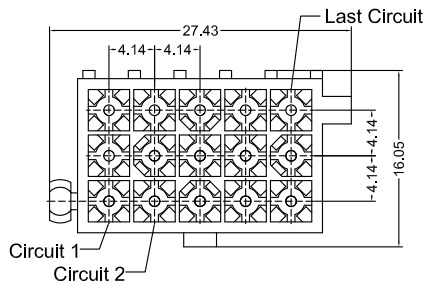

Recommended P.C.B Layout
General Tolerance ± 0.05

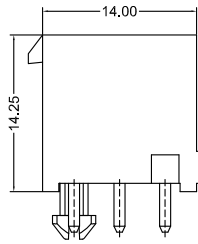
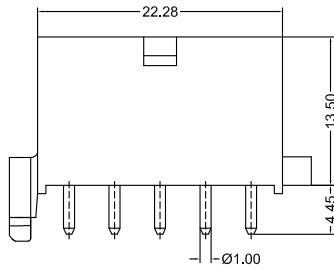

C4140VD 305 AP P6 TP C 9 001

- PIN
- 303=3X5PINS
- SPECIAL
- AP=Pillars
- Material
- P6=PA66 94-V0
- Finish
- TP=Tin-Plated
- Code
- 001
- Color
- 9=White
- Packing
- C=Bag Packing

