

A1255 FIS CONNECTOR

1.25mm Pitch/Disconnectable Crimp style connectors

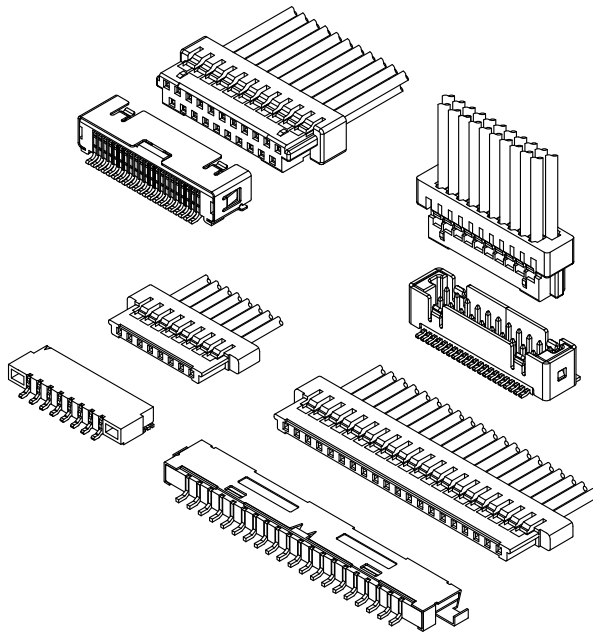

CSG E529482

Specifications:

- Current rating: 1.0 A / AC,DC
- Voltage rating: 200 V AC/DC
- Temperature range: -40°C ~ +105°C
(including temperature rise in applying electrical current)
- Contact resistance: Initial value/ 40m Ω max
Insulation resistance: 100 M Ω min
Withstanding voltage: 500 VAC/minute
Applicable wire: Conductor size/ AWG#32~#28
Insulation O.D./ 0.38 to 1.00 mm
- * Compliant with RoHS2/ REACH/ HF
- * Refer to "General Instruction and Notice when using Terminals and Connectors"
- * Contact CSG for details

Material:

Housing: PA66/UL94-V0;Color:Black
Terminal: Phosphor/ Tin-plated,Gold-Plated
SMT Wafer Housing: LCP/ PA6T,UL94-V0;
Color:A=Natural
SMT Wafer Pin: Phosphor/ Tin-plated,Gold-Plated
Wafer Fixed Foot: Brass/ Tin-plated

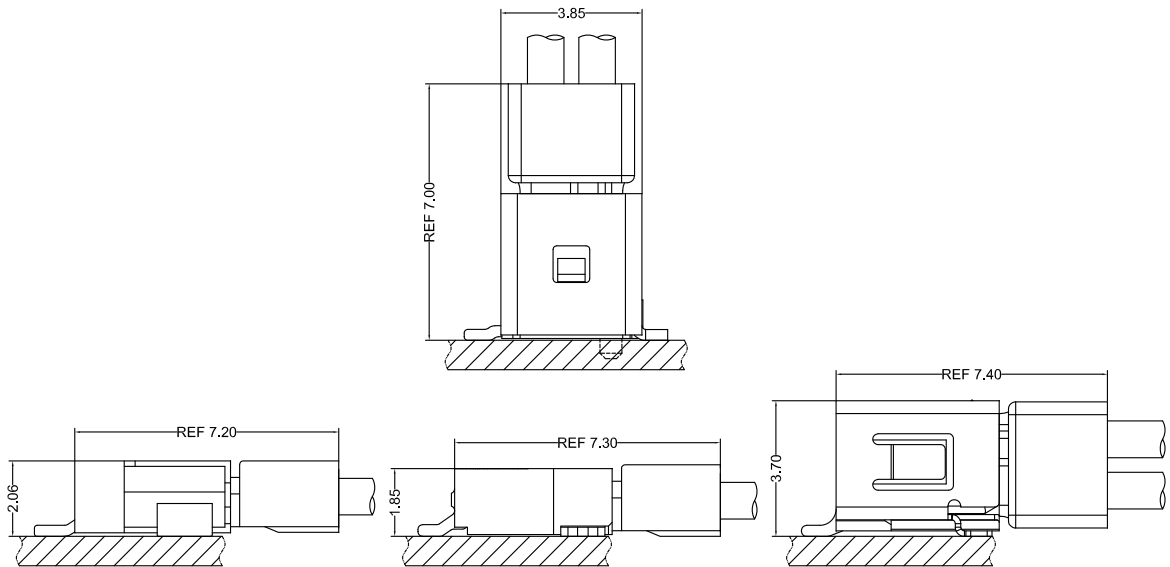

- Note: 1. The above figure is the figure viewed from the connector mounting side.
2. Tolerances are non-cumulative: ± 0.08 mm for all centers.
3. The dimensions above should serve as a guideline. Contact CSG for details.

CSG

A1255 FIS

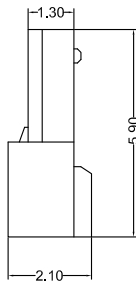
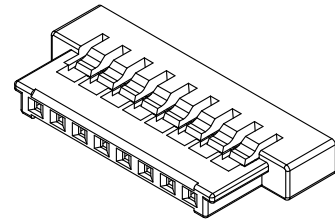
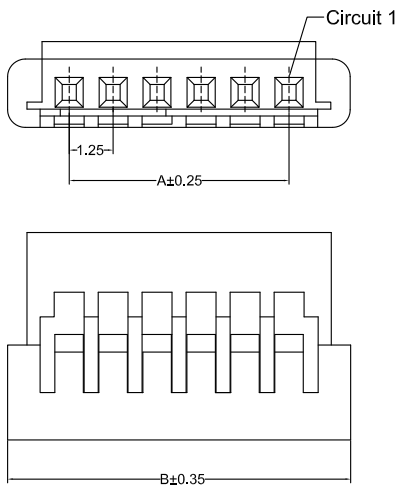

A1255HF 0XX AA P6 0 XXX

PIN
005=5PINS
SPECIAL
AA=NO Special
Material
P6=PA66 94V-0

Code
005 One convex
00A Two convex
Color
0=Black

CSG PART NO.	Dimension mm		Q'ty/BAG
	A	B	
A1255HF002AAP60XXX	1.25	6.00	1000PCS
A1255HF003AAP60XXX	2.50	7.25	1000PCS
A1255HF004AAP60XXX	3.75	8.50	1000PCS
A1255HF005AAP60XXX	5.00	9.75	1000PCS
A1255HF006AAP60XXX	6.25	11.00	1000PCS
A1255HF007AAP60XXX	7.50	12.25	1000PCS
A1255HF008AAP60XXX	8.75	13.50	1000PCS
A1255HF009AAP60XXX	10.00	14.75	1000PCS
A1255HF010AAP60XXX	11.25	16.00	1000PCS
A1255HF011AAP60XXX	12.50	17.25	1000PCS
A1255HF012AAP60XXX	13.75	18.50	1000PCS

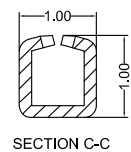
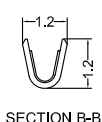
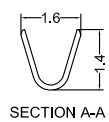
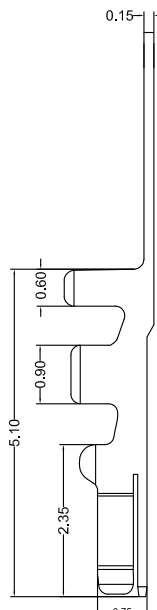
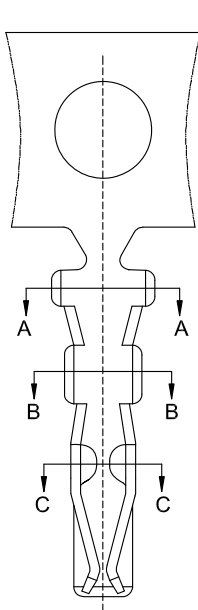

A1255 M 0 A XX 006

Type
M=Female Terminal
Material
A=Phosphor
Finish
TP=Tin-Plated
GF=Gold-Plated G/F
Code
006

CSG PART NO.	Wire Range	Insulation O.D.	Q'ty/Reel
A1255M0ATP006	AWG#28-#32	0.90mm(max)	15000PCS
A1255M0AGF006	AWG#28-#32	0.90mm(max)	15000PCS



A1255 FIS

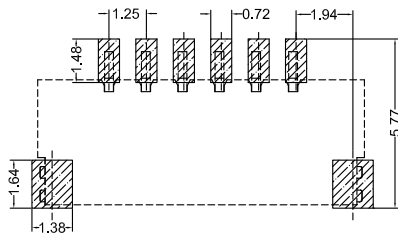
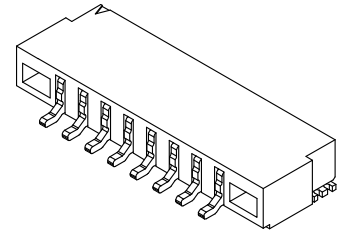
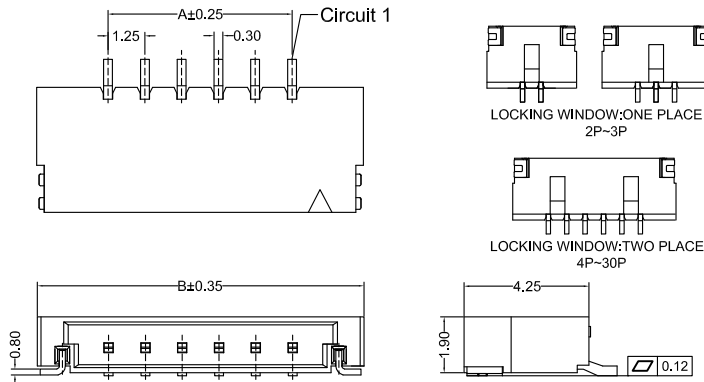

Recommended P.C.B Layout
General Tolerance±0.05

A1255RS_0XX AA LP TP B A 188

- PIN 005=5PINS
- SPECIAL AA=Normal
- Material LP=LCP 94V-0
- Finish TP=Terminal Tin-Plated
- Code 188
- Color A=Natural
- Packing B=Tape & Reel

CSG PART NO.	Dimension mm		Q'ty/Reel
	A	B	
A1255RS002AALPTPBA188	1.25	6.10	1000PCS
A1255RS003AALPTPBA188	2.50	7.35	1000PCS
A1255RS004AALPTPBA188	3.75	8.60	1000PCS
A1255RS005AALPTPBA188	5.00	9.85	1000PCS
A1255RS006AALPTPBA188	6.25	11.10	1000PCS
A1255RS007AALPTPBA188	7.50	12.35	1000PCS
A1255RS008AALPTPBA188	8.75	13.60	1000PCS
A1255RS009AALPTPBA188	10.00	14.85	1000PCS
A1255RS010AALPTPBA188	11.25	16.10	1000PCS
A1255RS011AALPTPBA188	12.50	17.35	1000PCS
A1255RS012AALPTPBA188	13.75	18.60	1000PCS
A1255RS013AALPTPBA188	15.00	19.85	1000PCS
A1255RS014AALPTPBA188	16.25	21.10	1000PCS
A1255RS015AALPTPBA188	17.50	22.35	1000PCS
A1255RS020AALPTPBA188	23.50	28.60	1000PCS
A1255RS025AALPTPBA188	30.00	34.85	1000PCS
A1255RS030AALPTPBA188	36.25	41.10	1000PCS

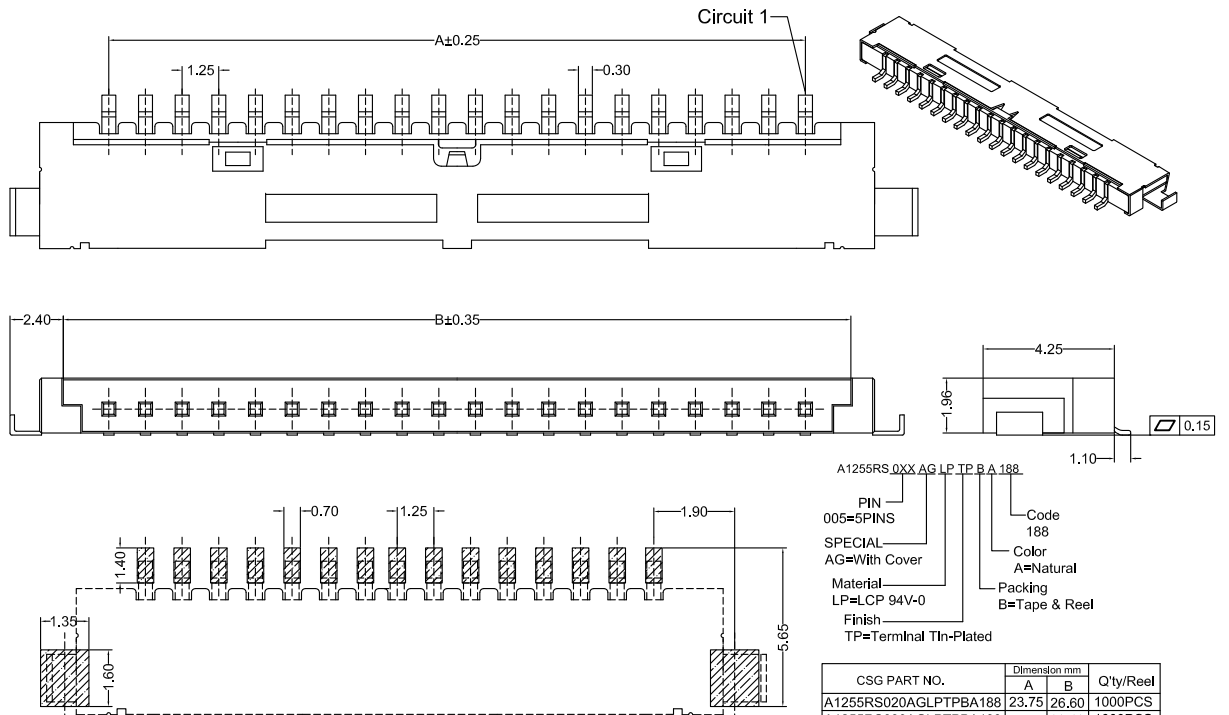

Recommended P.C.B Layout
General Tolerance±0.05

A1255RS_0XX AG LP TP B A 188

- PIN 005=5PINS
- SPECIAL AG=With Cover
- Material LP=LCP 94V-0
- Finish TP=Terminal Tin-Plated
- Code 188
- Color A=Natural
- Packing B=Tape & Reel

CSG PART NO.	Dimension mm		Q'ty/Reel
	A	B	
A1255RS020AGLPTPBA188	23.75	26.60	1000PCS
A1255RS030AGLPTPBA188	36.25	39.10	1000PCS



A1255 FIS

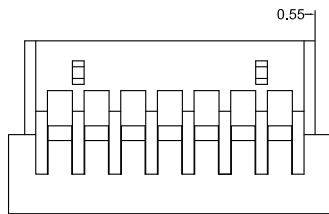
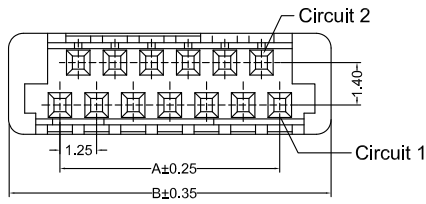

14P,17P,19P,21P,31,41P

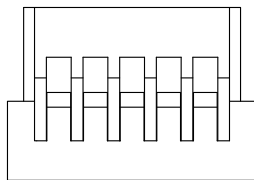
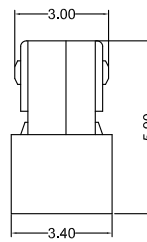

5P,7P,9P,11P

A1255HF 0XX AA P6 0 188
 PIN 005=5PINS
 SPECIAL
 AA=NO Special
 Material P6=PA66 94V-0
 Code 188
 Color 0=Black

CSG PART NO.	Dimension mm		Q'ty/BAG
	A	B	
A1255HF005AAP60188	2.50	6.00	1000PCS
A1255HF007AAP60188	3.75	7.25	1000PCS
A1255HF009AAP60188	5.00	8.50	1000PCS
A1255HF011AAP60188	6.25	9.75	1000PCS
A1255HF013AAP60188	7.50	11.00	1000PCS
A1255HF015AAP60188	8.75	12.25	1000PCS
A1255HF017AAP60188	10.00	13.50	1000PCS
A1255HF019AAP60188	11.25	14.75	1000PCS
A1255HF021AAP60188	12.50	16.00	1000PCS
A1255HF031AAP60188	18.75	22.25	1000PCS
A1255HF041AAP60188	25.00	28.50	1000PCS

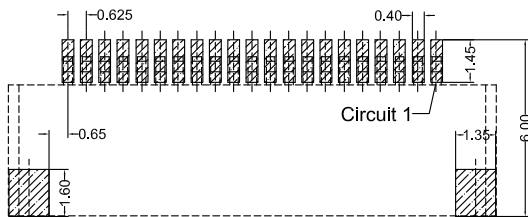
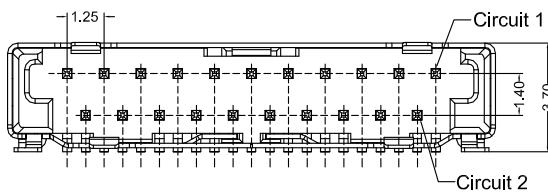
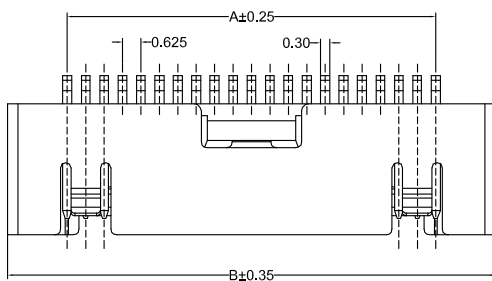

Recommended P.C.B Layout
 General Tolerance±0.05

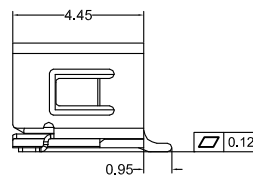

A1255RS 0XX AA 6T GF B A 188
 PIN 021=21PINS
 SPECIAL
 AA=Normal
 Material 6T=PA6T 94V-0
 Finish GF=Terminal Gold-Plated
 Code 188
 Color A=Natural
 Packing B=Tape & Reel

CSG PART NO.	Dimension mm		Q'ty/Reel
	A	B	
A1255RS021AA6TGFBA188	12.50	16.55	1000PCS
A1255RS031AA6TGFBA188	18.75	22.80	1000PCS
A1255RS041AA6TGFBA188	25.00	29.05	1000PCS



A1255 FIS

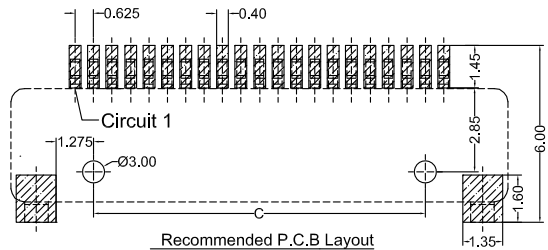
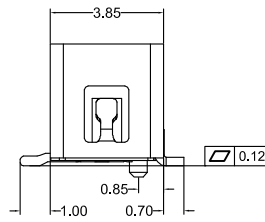
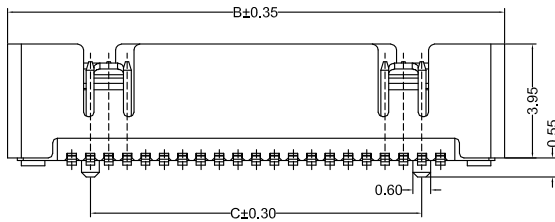
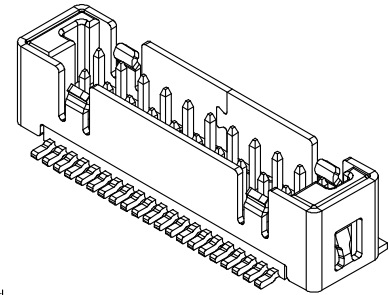
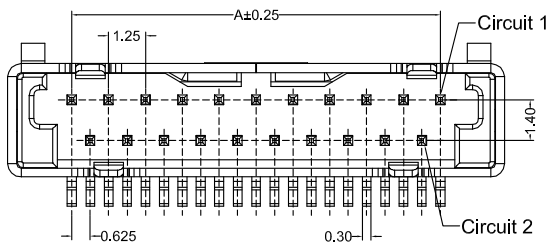

A1255VS 0XX AP 6T GF B A 188

PIN
021=21PINS
SPECIAL
AP=Pillars
Material
6T=PA6T 94V-0
Finish
GF=Terminal Gold-Plated

Code
188
Color
A=Natural
Packing
B=Tape & Reel

CSG PART NO.	Dimension mm		Q'ty/Reel
	A	B	
A1255VS021AP6TGFB A188	12.50	16.85	1000PCS
A1255VS031AP6TGFB A188	18.75	23.10	1000PCS

