

A1003 DF19 CONNECTOR

1.00mm Pitch/Disconnectable Crimp style connectors

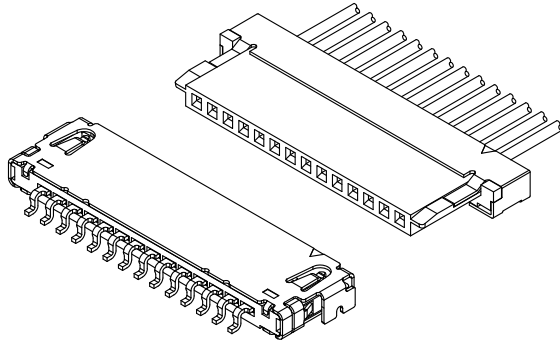

- The worlds first LVDS crimp style connector. It is used to connect the display screen to the main board. Height of 1.65 mm
- Compact, low profile design.



Specifications:

- Current rating: 1,0 A AC,DC (AWG #28)
 - Voltage rating: 100 V AC/DC
 - Temperature range: -40°C ~ +105°C
(including temperature rise in applying electrical current)
 - Contact resistance: Initial value/ 30m Ω max
After environmental testing/ 30m Ω max
 - Insulation resistance: 500 M Ω min
 - Withstanding voltage: 500 VAC/minute
 - Applicable wire: Conductor size/ AWG#32 to #28
Insulation O.D./ 0.4 to 0.6 mm
- * Compliant with RoHS2/ REACH
* In using the products, refer to "Handling Precautions for Terminals and Connectors "described on our website (Technical documents of Product information page).
* Contact CSG for details

Material:

Housing: PA66,UL94-V0;Color:Beige
Terminal: Phosphor/ Gold-Plated
Wafer Housing: PA6T,UL94-V0;Color:Beige
Wafer Pin: Phosphor/ Gold-Plated 3U"
Shell: Brass/ Tin-plated

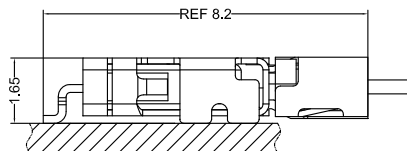

- Note: 1. The above figure is the figure viewed from the connector mounting side.
2. Tolerances are non-cumulative: ± 0.08 mm for all centers.
3. The dimensions above should serve as a guideline. Contact CSG for details.

CSG

A1003 DF19

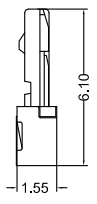
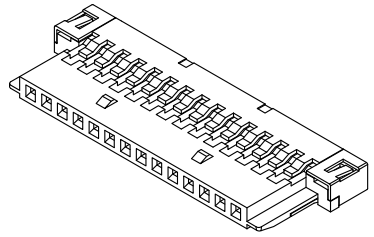
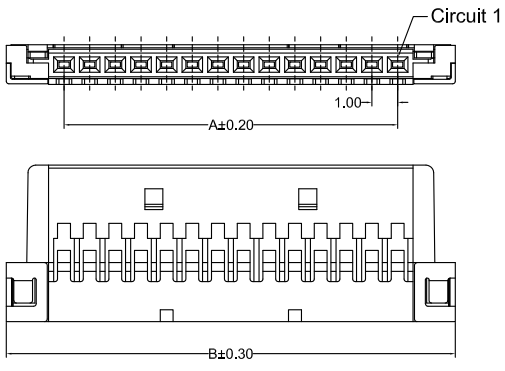

A1003HF 0XX AA P6 C 001
 PIN
 002=2PINS
 SPECIAL
 AA=NO Special
 Material
 P6=PA66 94V-0
 Code
 001
 Color
 C=Belge

CSG PART NO.	Dimension mm		Q'ty/BAG
	A	B	
A1003HF008AAP6C001	7.00	11.50	1000PCS
A1003HF014AAP6C001	13.00	17.50	1000PCS
A1003HF020AAP6C001	19.00	23.50	1000PCS
A1003HF030AAP6C001	29.00	33.50	1000PCS

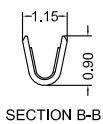
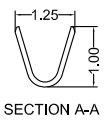
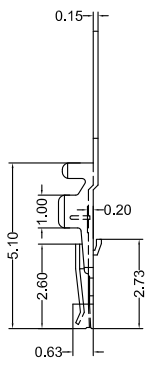
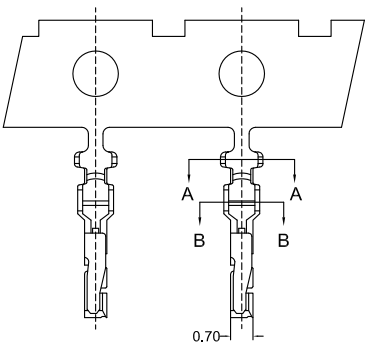

A1003 M 0 A GF 001
 Type
 M=Female Terminal
 Material
 A=Phosphor
 Finish
 GF=Gold-Plated
 Code
 001

CSG PART NO.	Wire Range	Insulation O.D.	Q'ty/Reel
A1003M0AGF001	AWG#28-#32	0.80mm(max)	3000PCS



A1003 DF19

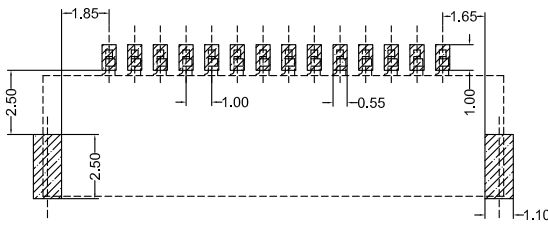
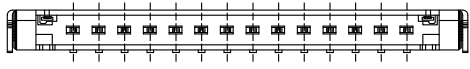
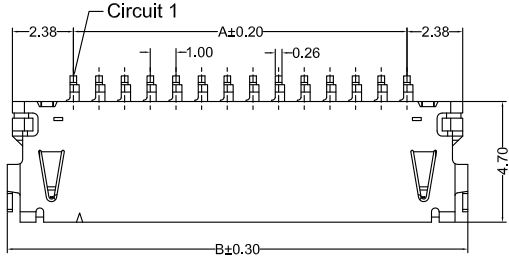

Recommended P.C.B Layout
General Tolerance±0.05

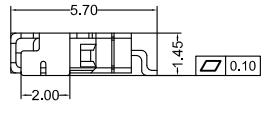
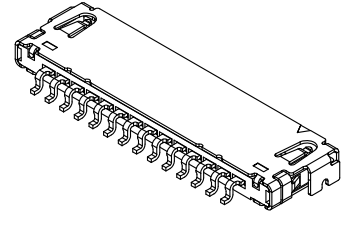

A1003RS 0XX AA 6T G1 B C 001

- PIN
- 002=2PINS
- SPECIAL
- AA=NO Spedal
- Material
- 6T=PA6T 94V-0
- Finish
- G1=Gold-Plated 3U"
- Code
- 001
- Color
- C=Beige
- Packing
- B=Tape & Reel

CSG PART NO.	Dimension mm		Q'ty/Reel
	A	B	
A1003RS008AA6TG1BC001	7.00	11.95	2000PCS
A1003RS014AA6TG1BC001	13.00	17.95	2000PCS
A1003RS020AA6TG1BC001	19.00	23.95	2000PCS
A1003RS030AA6TG1BC001	29.00	33.95	2000PCS

