

A1252 DF13 CONNECTOR

1.25mm Pitch/Disconnectable Crimp style connectors

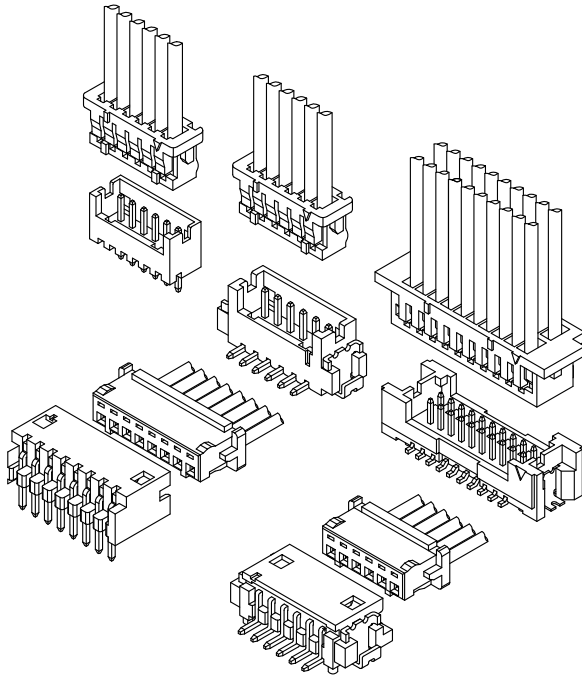

Specifications:

- Current rating: 1.0 A / AC,DC
- Voltage rating: 150 V AC/DC
- Temperature range: -40°C ~ +105°C
(including temperature rise in applying electrical current)
- Contact resistance: Initial value/ 30mΩ max
Insulation resistance: 500 MΩ min
Withstanding voltage: 500 VAC/minute
Applicable wire: Conductor size/ AWG#30~#26
Insulation O.D./ 0.40 to 1.10 mm
- * Compliant with RoHS2/ REACH
- * Refer to "General Instruction and Notice when using Terminals and Connectors"
- * Contact CSG for details

Material:

Housing: PA66/UL94-V0;Color: Gray
Terminal: Phosphor/ Tin-plated,Gold-Plated
DIP Wafer Housing: PA66/UL94-V0;Color: Gray
DIP Wafer Pin: Bass/ Tin-plated
SMT Wafer Housing: PA6T/,UL94-V0;Color:Natural
SMT Wafer Pin: Bass/ Tin-plated
Wafer Fixed Foot: Bass/ Tin-plated

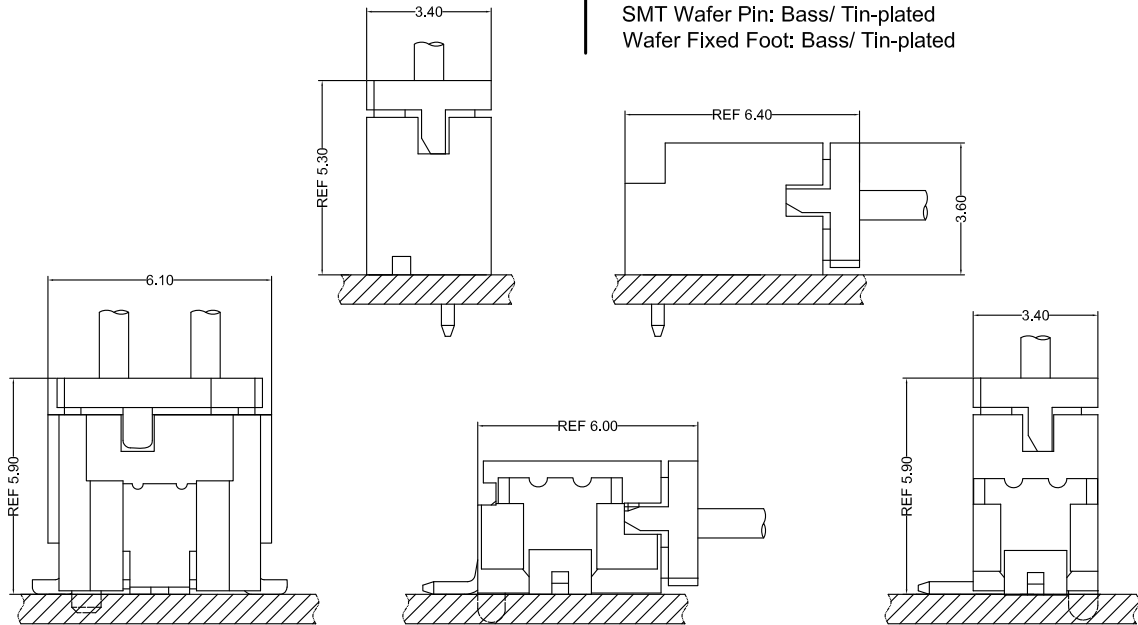

- Note: 1. The above figure is the figure viewed from the connector mounting side.
2. Tolerances are non-cumulative: ± 0.08 mm for all centers.
3. The dimensions above should serve as a guideline. Contact CSG for details.



A1252 DF13

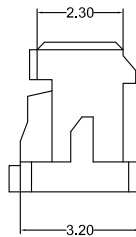
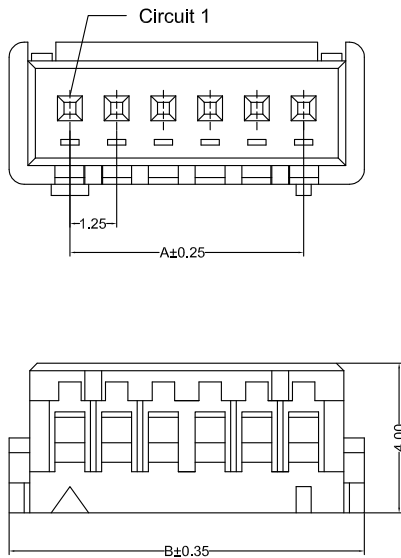

A1252HF 0XX AA P6 8 079

PIN
002=2PINS
SPECIAL
AA=NO Special
Material
P6=PA66 94V-0

Code
079
Color
8=Gray

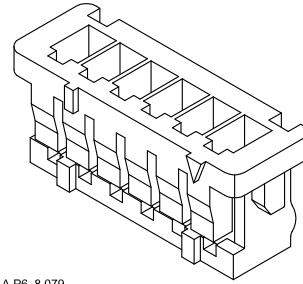

CSG PART NO.	Dimension mm		Qty/BAG
	A	B	
A1252HF002AAP68079	1.25	4.15	1000PCS
A1252HF003AAP68079	2.50	5.40	1000PCS
A1252HF004AAP68079	3.75	6.65	1000PCS
A1252HF005AAP68079	5.00	7.90	1000PCS
A1252HF006AAP68079	6.25	9.15	1000PCS
A1252HF007AAP68079	7.50	10.40	1000PCS
A1252HF008AAP68079	8.75	11.65	1000PCS
A1252HF009AAP68079	10.00	12.90	1000PCS
A1252HF010AAP68079	11.25	14.15	1000PCS
A1252HF011AAP68079	12.50	15.40	1000PCS
A1252HF012AAP68079	13.75	16.65	1000PCS
A1252HF013AAP68079	15.00	17.90	1000PCS
A1252HF014AAP68079	16.25	19.15	1000PCS
A1252HF015AAP68079	17.50	20.40	1000PCS

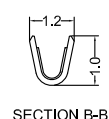
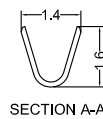
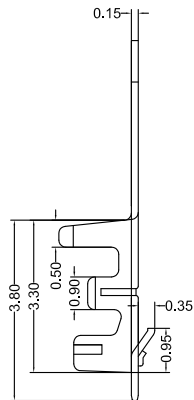
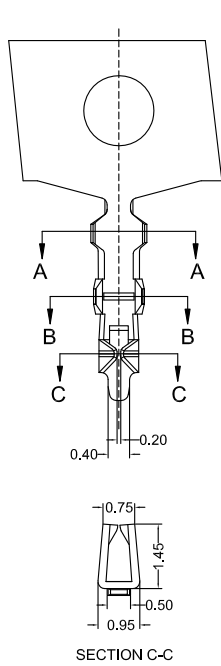

A1252 M 0 A XX 002

Type
M=Female Terminal
Material
A=Phosphor
Finish
TP=Tin-Plated
GF=Gold-Plated

Code
002

CSG PART NO.	Wire Range	Insulation O.D.	Q'ty/Reel
A1252M0ATP002	AWG#26-#30	1.10mm(max)	25000PCS
A1252M0AGF002	AWG#26-#30	1.10mm(max)	25000PCS



A1252 DF13

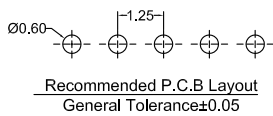
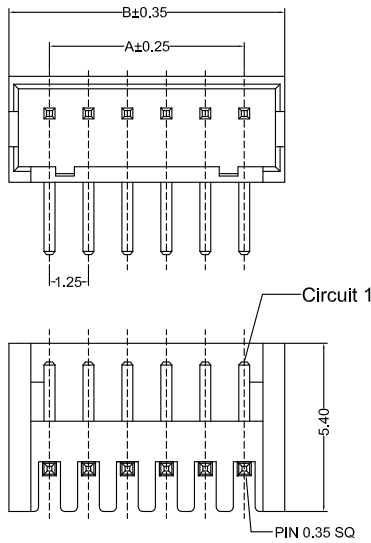

A1252RD_QXX AA P6 TP X 8 188

- PIN 005=5PINS
- SPECIAL AA=NO Special
- Material P6=PA66 94V-0
- Finish TP=Terminal Tin-Plated
- Code 188
- Color 8=Gray
- Packing C=Bag D=Box

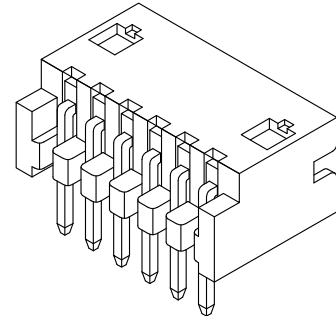

CSG PART NO.	Dimension mm		Q'ty
	A	B	
A1252RD002AAP6TPX8188	1.25	3.75	1000PCS
A1252RD003AAP6TPX8188	2.50	5.00	1000PCS
A1252RD004AAP6TPX8188	3.75	6.25	1000PCS
A1252RD005AAP6TPX8188	5.00	7.50	1000PCS
A1252RD006AAP6TPX8188	6.25	8.75	1000PCS
A1252RD007AAP6TPX8188	7.50	10.00	1000PCS
A1252RD008AAP6TPX8188	8.75	11.25	1000PCS
A1252RD009AAP6TPX8188	10.00	12.50	1000PCS
A1252RD010AAP6TPX8188	11.25	13.75	1000PCS
A1252RD011AAP6TPX8188	12.50	15.00	1000PCS
A1252RD012AAP6TPX8188	13.75	16.25	1000PCS
A1252RD013AAP6TPX8188	15.00	17.50	1000PCS
A1252RD014AAP6TPX8188	16.25	18.75	1000PCS
A1252RD015AAP6TPX8188	17.50	20.00	1000PCS

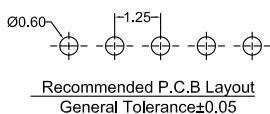
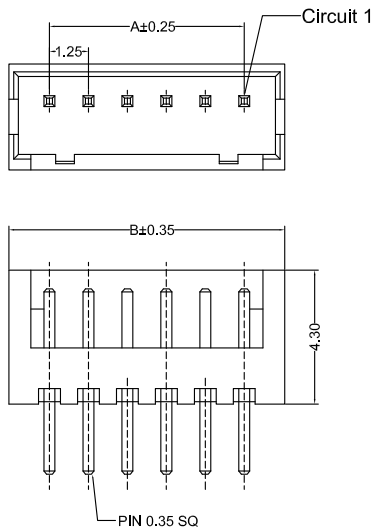

A1252VD_QXX AA P6 TP X 8 188

- PIN 005=5PINS
- SPECIAL AA=NO Special
- Material P6=PA66 94V-0
- Finish TP=Terminal Tin-Plated
- Code 188
- Color 8=Gray
- Packing C=Bag D=Box

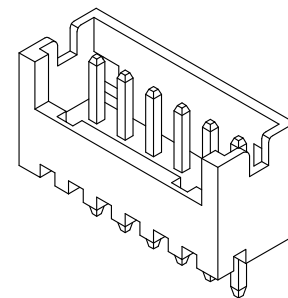

CSG PART NO.	Dimension mm		Q'ty
	A	B	
A1252VD002AAP6TPX8188	1.25	3.75	1000PCS
A1252VD003AAP6TPX8188	2.50	5.00	1000PCS
A1252VD004AAP6TPX8188	3.75	6.25	1000PCS
A1252VD005AAP6TPX8188	5.00	7.50	1000PCS
A1252VD006AAP6TPX8188	6.25	8.75	1000PCS
A1252VD007AAP6TPX8188	7.50	10.00	1000PCS
A1252VD008AAP6TPX8188	8.75	11.25	1000PCS
A1252VD009AAP6TPX8188	10.00	12.50	1000PCS
A1252VD010AAP6TPX8188	11.25	13.75	1000PCS
A1252VD011AAP6TPX8188	12.50	15.00	1000PCS
A1252VD012AAP6TPX8188	13.75	16.25	1000PCS
A1252VD013AAP6TPX8188	15.00	17.50	1000PCS
A1252VD014AAP6TPX8188	16.25	18.75	1000PCS
A1252VD015AAP6TPX8188	17.50	20.00	1000PCS

A1252 DF13

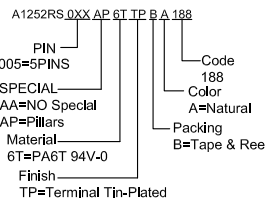
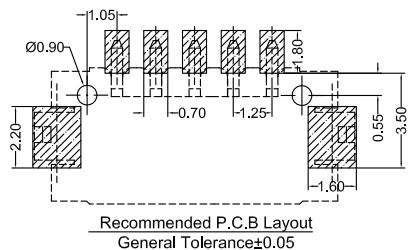
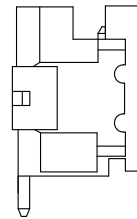
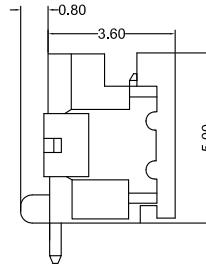
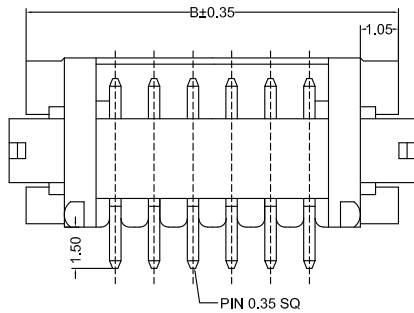
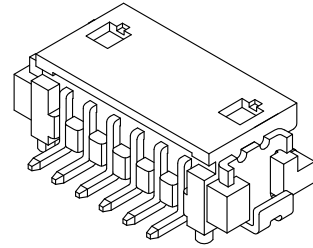
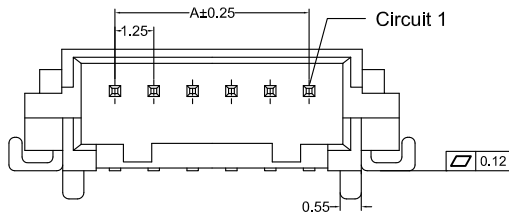

CSG PART NO.	Dimension mm		Q'ty/Reel
	A	B	
A1252RS002AX6TTPBA188	1.25	6.25	1000PCS
A1252RS003AX6TTPBA188	2.50	7.50	1000PCS
A1252RS004AX6TTPBA188	3.75	8.75	1000PCS
A1252RS005AX6TTPBA188	5.00	10.00	1000PCS
A1252RS006AX6TTPBA188	6.25	11.25	1000PCS
A1252RS007AX6TTPBA188	7.50	12.50	1000PCS
A1252RS008AX6TTPBA188	8.75	13.75	1000PCS
A1252RS009AX6TTPBA188	10.00	15.00	1000PCS
A1252RS010AX6TTPBA188	11.25	16.25	1000PCS
A1252RS011AX6TTPBA188	12.50	17.50	1000PCS
A1252RS012AX6TTPBA188	13.75	18.75	1000PCS
A1252RS013AX6TTPBA188	15.00	20.00	1000PCS
A1252RS014AX6TTPBA188	16.25	21.25	1000PCS
A1252RS015AX6TTPBA188	17.50	22.50	1000PCS

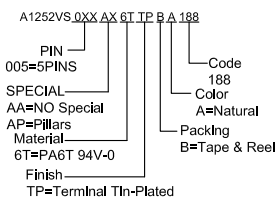
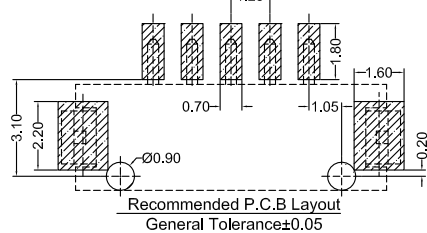
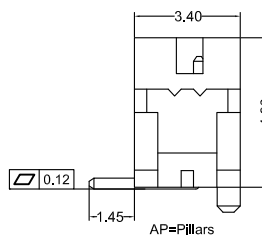
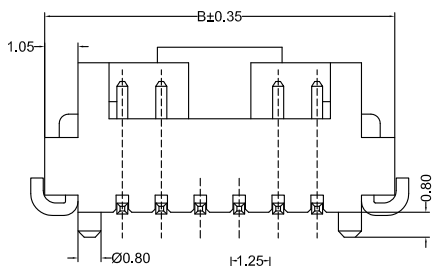
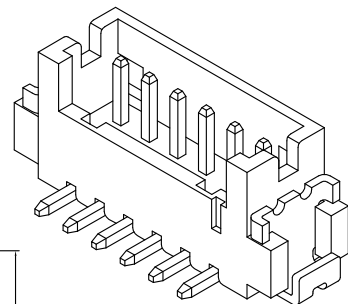
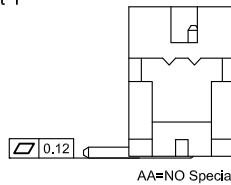
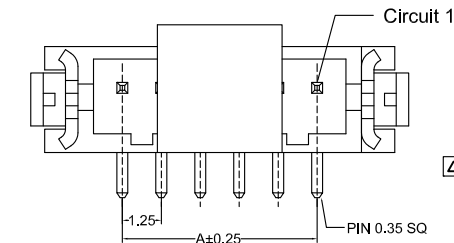

CSG PART NO.	Dimension mm		Q'ty/Reel
	A	B	
A1252VS002AX6TTPBA188	1.25	6.25	1000PCS
A1252VS003AX6TTPBA188	2.50	7.50	1000PCS
A1252VS004AX6TTPBA188	3.75	8.75	1000PCS
A1252VS005AX6TTPBA188	5.00	10.00	1000PCS
A1252VS006AX6TTPBA188	6.25	11.25	1000PCS
A1252VS007AX6TTPBA188	7.50	12.50	1000PCS
A1252VS008AX6TTPBA188	8.75	13.75	1000PCS
A1252VS009AX6TTPBA188	10.00	15.00	1000PCS
A1252VS010AX6TTPBA188	11.25	16.25	1000PCS
A1252VS011AX6TTPBA188	12.50	17.50	1000PCS
A1252VS012AX6TTPBA188	13.75	18.75	1000PCS
A1252VS013AX6TTPBA188	15.00	20.00	1000PCS
A1252VS014AX6TTPBA188	16.25	21.25	1000PCS
A1252VS015AX6TTPBA188	17.50	22.50	1000PCS



A1252 DF13

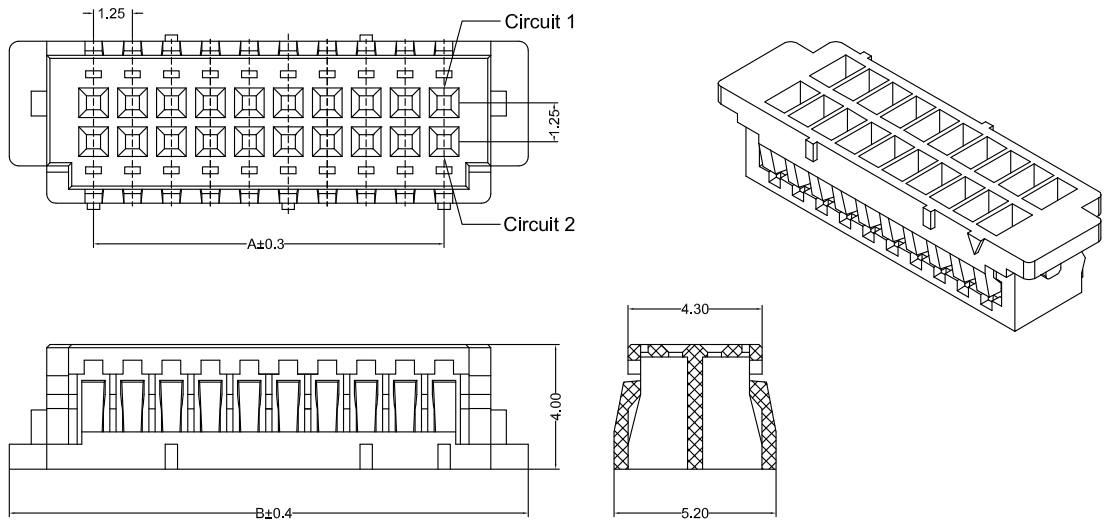

A1252HF 2XX AA P6 8 110
 PIN 205=2X5PINS
 SPECIAL AA=NO Special
 Material P6=PA66 94V-0
 Code 110
 Color 8=Gray

CSG PART NO.	Dimension mm		Q'ty/BAG
	A	B	
A1252HF205AAP68110	5.00	10.40	1000PCS
A1252HF206AAP68110	6.25	11.65	1000PCS
A1252HF207AAP68110	7.50	12.90	1000PCS
A1252HF10AAP68110	11.25	16.65	1000PCS
A1252HF215AAP68110	17.50	22.90	1000PCS
A1252HF220AAP68110	23.75	29.15	1000PCS

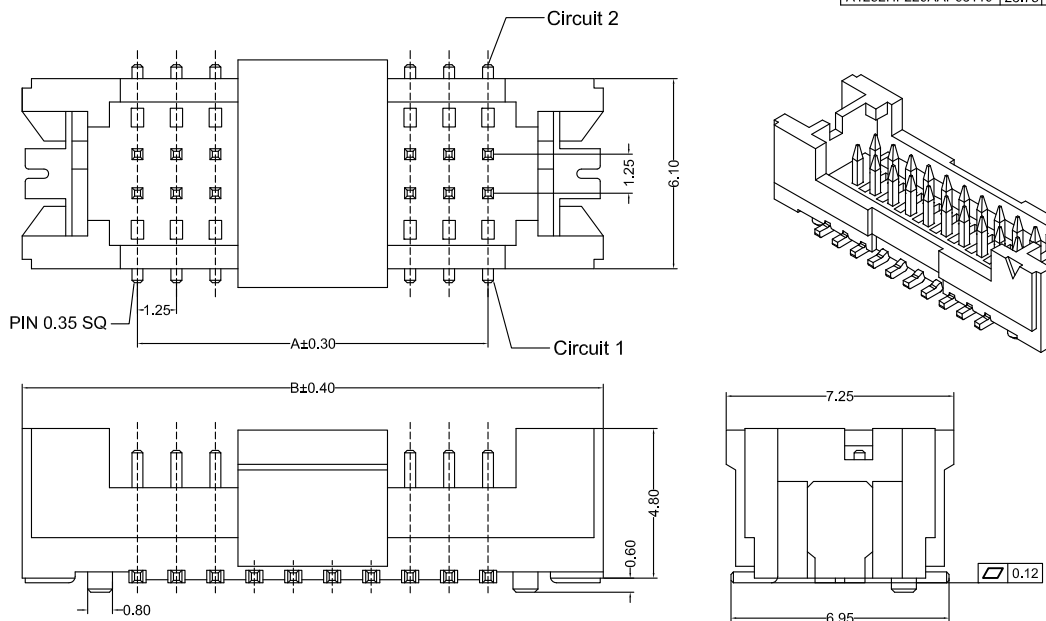

A1252VS 2XX AX 6T TP B A 016
 PIN 205=2X5PINS
 SPECIAL AA=NO Special
 AP=Pinbars
 Material 6T=PA6T 94V-0
 Finish TP=Terminal Tin-Plated
 Code 016
 Color A=Natural
 Packing B=Tape & Reel

CSG PART NO.	Dimension mm		Q'ty/Reel
	A	B	
A1252VS205AX6TTPBA016	5.00	12.50	1000PCS
A1252VS210AX6TTPBA016	11.25	18.75	1000PCS
A1252VS215AX6TTPBA016	17.50	25.00	1000PCS
A1252VS220AX6TTPBA016	23.75	31.25	1000PCS

Recommended P.C.B Layout
 General Tolerance±0.05

